

Personal Computer
Model No. CF-53 Series
Model No. CF-52 Series
Reference Manual

<CF-53 Series>



<CF-52 Series>



We recommend that this Reference Manual be printed.



Descriptions

- For common procedures and screens for Windows 7 and Windows XP, this Reference Manual uses the procedures and screens of Windows 7.
- Some menus may differ for Windows XP.
- Windows XP does not require clicking operation to  of the notification area.

• Disclaimer

Computer specifications and manuals are subject to change without notice. Panasonic Corporation assumes no liability for damage incurred directly or indirectly from errors, omissions or discrepancies between the computer and the manuals.

• Trademarks

- Microsoft, Windows, and the Windows logo are registered trademarks or trademarks of Microsoft Corporation of the United States and/or other countries.
- Intel, Core, and PROSet are either registered trademarks or trademarks of Intel Corporation.
- SDXC Logo is a trademark of SD-3C, LLC.



- Adobe, the Adobe logo and Adobe Reader are either registered trademarks or trademarks of Adobe Systems Incorporated in the United States and/or other countries.
- Bluetooth™ is a trademark owned by Bluetooth SIG, Inc., U.S.A. and licensed to Panasonic Corporation.
- HDMI, the HDMI Logo and High-Definition Multimedia Interface are trademarks or registered trademarks of HDMI Licensing LLC in the United States and other countries.
- InterVideo, WinDVD™, the InterVideo logo, Ulead and the Corel logo are trademarks or registered trademarks of Corel Corporation and/or its subsidiaries in Canada, the United States and/or other countries.
- Sonic ,Roxio and Roxio Creator are trademarks or registered trademarks of Sonic in the United States and/or other countries.
- Names of products, brands, etc., appearing in this manual are trademarks or registered trademarks of their respective own companies.

CD0311-1041

PCF0320B_XP/7

© Panasonic Corporation 2011

Introduction

This manual explains using the Windows 7 or Windows XP default setting. In these instructions, the names are referred as follows.

«Enter»

This means to press the Enter key.

Windows 7

"Genuine Windows® 7 Professional 32-bit Service Pack 1" and "Genuine Windows® 7 Professional 64-bit Service Pack 1" as "Windows" or "Windows 7"

Windows XP

"Genuine Microsoft® Windows® XP Professional" as "Windows" or "Windows XP"

Windows Update

You can update to the latest patches and service packs for Windows with the following menus.

1. Click  (Start)^{*1} - [All Programs] - [Windows Update].

Do not apply "Driver Updates" even if a message to update a driver appears. If a driver update is required, contact your technical support office.

*1: Windows XP: [start]

Regarding Windows 7 **Windows 7**

Sound and Video

- **Sound (e.g. MP3, WMA) and video (e.g. MPG, WMV) recorded in PC Cards and SD Memory Cards may be interrupted during playback. If this happens, copy them to the hard disk drive and play back.**
- **Depending on the processing status on Windows, sound may be interrupted at Windows startup. You can mute the sound at startup.**
 1. Right-click the desktop and click [Personalize] - [Sounds].
 2. Remove the check mark from [Play Windows Startup sound], and click [OK].

When high-frequency sound occurs

If high-frequency sound occurs around keyboard while using the computer, check the settings for the USB power saving function.

A standard user needs to enter an administrator password and click [OK].

- **Set [USB selective suspend setting] to [Enabled].**
 1. Click  (Start) - [Control Panel] - [System and Security] - [Power Options].
 2. Click [Change plan settings] of the current power plan.
 3. In [Change settings for the plan], click [Change advanced power settings].
 4. In [Advanced settings], double-click [USB settings].
 5. Double-click the displayed [USB selective suspend setting].
 6. Change settings of [On battery] and [Plugged in] to [Enabled].
 7. Click [OK] and exit the [Advanced settings] screen.

Useful functions of the Touch Pad <Only for CF-53 Series>

In addition to clicking and dragging, you can use the following functions with the Touch Pad.

- **Vertical scroll**

Trace the Touch Pad vertically with two fingers.

Or place one finger on the right side of the Touch Pad and slide finger in the desired direction of scrolling and begin making a circular motion.

- **Horizontal scroll**

Trace the Touch Pad horizontally with two fingers.

Or place one finger on the lower edge of the Touch Pad and slide finger in the desired direction of scrolling and begin making a circular motion.

- **Sliding pictures**

Trace the Touch Pad horizontally with three fingers.

- **Picture rotation**

Trace the Touch Pad like writing a circle with two fingers.

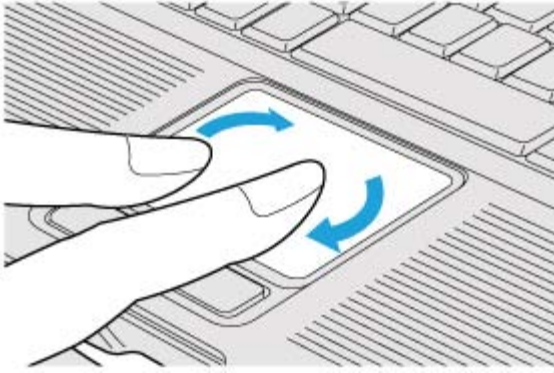

- **Picture zoom-out/zoom-in**

Place two fingers slightly separated on the Touch Pad. Slide both fingers, using a straight continuous motion, closer together to zoom-out. Slide both fingers farther apart to zoom-in.

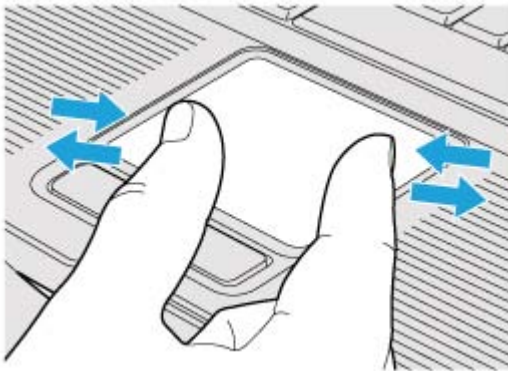





Key Combinations

NOTE

- Do not repeatedly press the keys in quick succession.
- Do not use the key combinations together with touch pad (external mouse), touchscreen (only for model with touchscreen) or other key operations.
- Do not use the key combinations before you log on to Windows. Wait until the drive indicator  turns off. On the Setup Utility screen, you can use the key combinations of «Fn» + «F1», «Fn» + «F2» and «Fn» + «F3». By using the key combinations of «Fn» + «F3», the display is switched between the internal LCD, simultaneous display^{*1} and the external display.
- The key combinations may not work with some applications.
- The pop-up icon appears after logging on to Windows. It may not appear in some application conditions.

*1 : Only for CF-52 Series

Key	Function	Pop-up icon
«Fn» + «F1» ^{*2} «Fn» + «F2» ^{*2}	LCD brightness («Fn» + «F1» = down / «Fn» + «F2» = up)	
«Fn» + «F3»	Display mode switching ( Switching the display mode) When an external display (a projector etc.) is connected, you can change the display mode. Windows 7 1. Press «Fn» + «F3». 2. Click the display mode. (Disconnect Projector/Duplicate/Extend/Projector only) The change you made may not be effective until «Enter» is pressed. You can also change the display mode by pressing «  » + «P». Windows XP <CF-53 Series> LCD → LCD + HDMI display (port replicator side) ^{*3} → HDMI display (port replicator side) ^{*3} → LCD + HDMI display (computer	

side) → HDMI display (computer side) → LCD + analog display → analog display → HDMI display (computer side) + analog display → LCD

<CF-52 Series>

Internal LCD → Simultaneous display → External display → Internal LCD

NOTE

<Only for CF-52 Series>

- When an external display is connected to an optional port replicator (CF-VEB522), the display switching may work differently from the above. For further information, refer to the instruction manual of the port replicator.

CAUTION

- Do not press any keys until the display has finished switching.
- Do not use this function:
 - When playing motion video such as DVD or MPEG.
 - When an external display is not connected.
 - When showing a game screen such as pinball.
 - **Windows XP**
When using the Extended Desktop.

«Fn»
+ «F4»^{*2}

Speaker on/off

NOTE

- Beeps do not sound if you turn off the speaker sound^{*4}.



:OFF(MUTE)







:ON

«Fn»
+ «F5»^{*2}

Volume



(«Fn» + «F5» = down / «Fn» + «F6» = up)



«Fn» + «F6»*2	<p style="text-align: center;">NOTE</p> <hr/> <ul style="list-style-type: none"> - When fine-tuning the sound volume, press and hold «Fn», and press «F5» or «F6» intermittently. - This does not work on beeps or speakers connected to the USB port. <hr/>	
«Fn» + «F7»	<p>Activate sleep*5 (➡ Entering/Resuming from Sleep or Hibernation)</p>	
«Fn» + «F8»	<p>Concealed Mode on/off You can select on/off of LCD Backlight, LED, Sound*4, Wireless Radio, Backlit Keyboard and Fan.</p> <p style="text-align: center;">NOTE</p> <hr/> <ul style="list-style-type: none"> - You have to set [Concealed Mode] to [Enabled] in Setup Utility. - You can set the devices turned off in [Concealed Mode] with Setup Utility. - If you press «Fn» + «F8» in succession, the Concealed Mode may not be switched. More than 4 minutes interval is necessary to switch on/off. <hr/>	
«Fn» + «F9»	<p>Remaining battery charge (When the battery pack is inserted in the computer)</p>	 <p>(➡ Checking the Remaining Battery Charge)</p>
«Fn» + «F10»	<p>Activate hibernation (➡ Entering/Resuming from Sleep or Hibernation)</p>	

*2 : These key combinations are disabled when [Concealed Mode] is enabled.

*3 : Only when a port replicator having an HDMI port is connected.

*4 : Even if [Sound] is set to [OFF] on the [Concealed Mode Configuration] menu,  or  icon on the notification area and [Volume] in [Sound-MAX] display do not show mute state. However, audio from the speaker is not heard.

*5 : Windows XP: standby

Hotkey Settings

You can make 2 settings:

- **Fn key lock**

When you press «Fn», the key is locked (pressed-down) until you press another key. Use this when pressing difficult key combinations.

- **Pop-up icon on/off**

1. Start up the Hotkey Settings.

Click  (Start)^{*6} - [All Programs] - [Panasonic] - [Hotkey Settings].

2. Make the settings.

[Use Fn key lock]



- When using an «Fn» key combination
 1. Press «Fn» once. (Locked)
 2. Press another key. (Lock released)
- When using successive «Fn» key combinations
 1. Press «Fn» twice. (Locked)
 2. Press another key.

Fn key remains locked until you press «Fn» again.

[Notification]

[Make sounds when Fn key is pressed]^{*7}

[Show status on screen]: Displays the Fn key status when  on the notification area is clicked.

-  : «Fn» is locked.
-  : «Fn» is not locked.

[Disable popup]

The pop-up icon will not be displayed.

[Display status bar while Fn Key is held down]^{*8}

[Status bar position]: Select [TOP] or [Bottom].

3. Click [OK].

NOTE

- You can have different settings for each user.

*6 : Windows XP: [start]

*7 : If the speaker is muted or [Sound] is turned off in [Concealed Mode Configuration], beeps do not sound.

*8 : Windows XP: [Display status bar while pressing Fn Key]

Touchscreen

<Only for model with touchscreen>

You can use the touchscreen function to perform the same operation as the touch pad and mouse. Touch the screen surface with your finger or the stylus (included).

Windows 7





For further information, click  (Start) - [Control Panel] - [Hardware and Sound] - [Pen and Touch] - [Flicks] - [Practice using flicks].

- **To right-click**

Windows 7

1. Touch and hold with the stylus, or touch and select the right button of "touch pointer".

Windows XP

1. Click  on the notification area.
 changes to .
2. Click the object you want to right-click.
 returns to .

NOTE

- **The touchscreen function does not work in the Setup Utility.**

Windows XP

- **You need to make the following setting for each user.**

1. Click [start] - [All Programs] - [Fujitsu Touch Panel (USB)] - [Touch Panel Configuration].
2. Select the settings, and then click [OK].
 - Do not add a check mark to [Delete Cursor] since the display may be distorted.

- **If you add a check mark for [Use] in [Hold [Ctrl] key down + Touch the screen] of [Touch Panel Configuration], touching the screen may always be recognized as a right-click. To return to the normal operation, press «Ctrl» on the keyboard.**

- **The touchscreen function does not work in the Setup Utility, in the full screen of [Command Prompt].**

Operation of the touchscreen

Operate the touchscreen with your finger or with an approved stylus

When using the touchscreen function, use only your finger or an approved stylus on the surface. Operating the touchscreen with an object other than your fingertip or the stylus (a fingernail or metal object, or other hard or sharp objects that may leave a mark) may scar or stain the surface, causing the touchscreen to malfunction.

Do not apply too much pressure when operating the touchscreen

Only a light touch is required to operate the touchscreen. Applying too much pressure may damage the surface.

Maintaining the performance of the touchscreen

When the touchscreen becomes dirty, wipe it with an approved soft cloth

The touchscreen is specially treated to prevent dirt from adhering to the surface, so dirt can be removed easily using a dry cloth (use only the approved soft cloth). If the dirt does not come off easily, breathe on the surface and try again.

Do not apply water or solvents to the soft cloth.

Suggestions About Cleaning the LCD Surface

To improve the outdoor visibility of the display, a low reflection coating has been added. In order to avoid scratches and peeling of this coating, an approved soft cloth has been included to wipe the LCD surface of the computer. Before using the computer, be sure to read the instructions provided below.

- Be sure to wipe the LCD display to remove fingerprints, etc., with the soft cloth.
- Do not wipe areas other than the LCD display with the soft cloth.

<How to use the soft cloth>

- Use the soft cloth when it is dry. Do not apply water or solvents to the soft cloth.
- First, lightly wipe foreign particles and dust adhering to the LCD display on one side of the soft cloth. Do not use force, since the LCD surface may be damaged with the foreign particles or dust.

Next, wipe off fingerprint, etc., with the other side of the soft cloth.

After wiping off foreign particles and dust, wash the soft cloth (refer to the following) to remove the foreign particles and dust from the soft cloth.

- When the soft cloth becomes dirty, wash it with neutral detergent. Do not use bleach or a fabric conditioner (softener), or carry out sterilization by boiling.
- If the LCD gets wet, wipe the surface lightly with the soft cloth.
- While wiping the LCD display, the computer must be turned off.

Clean the touchscreen while the computer is powered off

Cleaning the screen while the power is on may cause the computer to malfunction. Also, dirt on the touchscreen is easier to see when the computer is powered off, and so is easier to clean.

Wash the soft cloth when it becomes dirty

When the soft cloth becomes dirty, wash it with mild detergent. Do not use bleach or fabric conditioner (softener), or try to sterilize the cloth by boiling.

If the soft cloth is dirty, it may be ineffective in cleaning the touchscreen, and in fact may cause dirt to adhere to the touchscreen.

Check the following to prevent the surface of the touchscreen from being scratched

- Are you using your finger or a stylus to operate the touchscreen?
- Is the surface clean?
- Is the soft cloth clean?
- Are you using the stylus with the tip extended?
- Is the tip of the stylus clean?
- Is your finger clean?

Things to keep in mind when using the touchscreen

Do not touch the screen outside of the LCD display area

The touchscreen input area is defined by the LCD display screen. Touching the screen outside of the display area may result malfunctions or damage to the touchscreen.

Do not apply excessive force to the touchscreen

Do not lift the computer while holding the LCD screen, or allow the screen to be twisted. Do not

place any objects on the LCD screen. Any of the above may cause the touchscreen glass to break, or may damage the LCD screen.

Operation response may be slower in low temperature environments

The touchscreen may respond to operations more slowly when using the computer in temperatures less than 5 °C, but this is not a malfunction. Response time will return to normal when the computer is returned to room temperature.

If the cursor jumps to a location other than where the screen was touched, or if the LCD resolution changes, recalibrate the touchscreen

Perform the procedure of "Touchscreen Calibration" (below).

Touchscreen Calibration

Windows 7

A standard user needs to perform the calibration as an administrator before performing the calibration for each user.

Calibration by an administrator

NOTE

- At first, log on to Windows as an administrator, and perform this calibration.

1. Run [Tablet PC Settings].

Click  (Start) - [Control Panel] - [Hardware and Sound] - [Tablet PC Settings].

2. Click [Calibrate].

3. Using the stylus, touch each of the "+" target marks one by one

Calibration by a standard user

NOTE

- Perform the following calibration for each user.

1. Run [Tablet PC Settings].

Click  (Start) - [Control Panel] - [Hardware and Sound] - [Tablet PC Settings].

2. Click [Calibrate].**3. Using the stylus, touch each of the "+" target marks one by one, and then click [OK].**

- Perform the calibration for the orientation to be used.

Windows XP**1. Run [Touch Screen Calibration Utility].**

Click [start] - [All programs] - [Fujitsu Touch Panel (USB)] - [Touch Screen Calibration Utility].

2. Using the stylus, touch each of the "+" target marks one by one, and then press «Enter».**3. Press «Enter».****NOTE**

- Perform the touchscreen calibration for each user.



Hand Writing Utility

You can make a bitmap file (.bmp) of a simple character and a figure such as signature by handwriting on the touch pad and the touchscreen (only for model with touchscreen).

CAUTION

- Do not use the Fast User Switching function while Hand Writing Utility is active.
 - If you install other pointing devices (e.g., commercially available mouse driver) and overwrite the touch pad driver, Hand Writing Utility will not work.
-



NOTE

- The display of Hand Writing Utility may be distorted if the number of display colors is changed. Click  on the notification area and right-click , then click [Exit Hand Writing Utility], and then restart Hand Writing Utility.
 - Hand Writing Utility may not work properly if another application software is active. In this case, close the application software and try handwriting again.
-
-

Installing the utility

1. Log on to Windows as an administrator.
 2. **Windows 7**
Click  (Start), input "c:\util\writing\setup.exe" in [Search programs and files], and press «Enter».
Windows XP
Click [start] - [Run] and input "c:\util\writhing\setup.exe", and click [OK].
 3. Follow the on-screen instructions to install the Utility.
-

Starting Hand Writing Utility

1. Click  on the notification area, and double-click .
Alternatively you can click  (Start)^{*1} - [All Programs] - [Panasonic] - [Hand Writing Utility].

NOTE

- **Select the image size before handwriting by clicking [Option] - [Window size]. If you change the size after handwriting, the image quality will become lower.**
 - **You can copy the bitmap image by clicking [Edit] - [Copy], and paste it in another application software that supports bitmap format.**
 - **The touch pad mode may not work properly when using the extended desktop.**
 - **The touch pad mode may not work properly when the display is rotated 90 or 270 degree.**
 - **The touch pad mode may be canceled in the following cases.**
 - Switching to another application
 - Resuming from sleep^{*2} or hibernation
 - Pressing «Alt»
 - Touching the touchscreen (only for model with touchscreen)
 - **An external mouse or trackball connected via the keyboard/mouse port of port replicator (optional) or the car mounter (optional) will not work during handwriting in the touch pad mode.**
-

*1 : Windows XP: [start]

*2 : Windows XP: standby

Sleep and Hibernation Functions

Starting Up Your Computer Quickly

The sleep^{*1} or hibernation functions allow you to shut off the computer without closing programs and documents. You can quickly return to the programs and documents that you were working on before sleep^{*1} or hibernation.



Function	Data is saved to	Recovery time	Power supply
Sleep ^{*1}	Memory	Short	Required. (If power is not supplied, all data will be lost.)
Hibernation	Hard disk	Rather long	Not required. (However power is slightly consumed to keep the hibernation.)

*1 : Windows XP: standby

Setting Sleep or Hibernation

Windows 7

Sleep

1. Click  or  on the notification area, and click [More power options].
2. Click [Change plan settings] of the power plan you want to change.
3. Select the setting for [Put the computer to sleep], and then click [Save changes].
 - o The setting for hibernation may change unexpectedly when you change the setting for sleep. Confirm that the time to enter hibernation is 1,080 minutes (default setting) or longer (below).

Hibernation

1. After the step 2 of "Sleep" setting (above), click [Change advanced power settings].
2. Double-click [Sleep], and double-click [Hibernate after].
3. Click the item and select the setting.

4. Click [OK].

Windows XP



Standby / Hibernation

1. Click [start] - [Control Panel] - [Performance and Maintenance] - [Power Options] - [Advanced].
2. Select [Stand by] or [Hibernate] for [When I close the lid of my portable computer] / [When I press the power button on my computer], and then click [OK].

NOTE

- You do not need to make the setting if you use the Windows menu to enter standby or hibernation.
-
-

Precautions

- Connect the AC adaptor if the computer will be in sleep^{*2} for a long period of time. If you cannot use the AC adaptor, use hibernation instead.
- Using sleep^{*2} or hibernation repeatedly may cause malfunction of the computer. To stabilize computer operation, restart Windows regularly (about once a week) without using sleep^{*2} or hibernation.
- Save the necessary data.
- Close files you have opened from removable disks and network drives.
- Do not enter sleep^{*2} or hibernation in the conditions below, otherwise the data or file may be corrupted, sleep^{*2} or hibernation may not work, or malfunction may occur in the computer or the peripheral devices.
 - When any of the drive indicator  or the SD Memory Card indicator  is on.
 - When playing/recording audio files or displaying motion video such as MPEG files.
 - When playing a DVD-Video.
 - When writing to a disc.
 - When using communication software or network functions.
 - When using peripheral devices.
(If peripheral devices fail to work normally, restart the computer.)

- **Windows XP**

When an external mouse is connected to the serial port.

- **The password you set in the Setup Utility is not requested at resuming. To enable it, select [Enabled] in [Password On Resume] in the [Security] menu of the Setup Utility.**

CAUTION

The following problems will occur when you fail the password input (failing three times or leaving the computer unattended for one minute or more) while resuming from sleep^{*2} or hibernation.

- Failing the password input while resuming from hibernation:

- At the next resume, Panasonic boot screen will appear. At this time, do not start the Setup Utility and do not change settings. Otherwise, resume may not operate correctly.
- Cannot resume from hibernation by the Wake Up from wired LAN function, the Task Scheduler or the operation to open the display.

- Failing the password input while resuming from sleep^{*2}:

- Cannot resume from sleep^{*2} using the USB devices.
-

*2 : Windows XP: standby

Entering/Resuming from Sleep or Hibernation

To enter sleep^{*3} or hibernation

1. **Close the display, or press the power switch (A) until a beep^{*4} sounds.**

Sleep^{*3}: The power indicator (B) blinks green.

Hibernation: The power indicator (B) goes off.

<CF-53 Series>

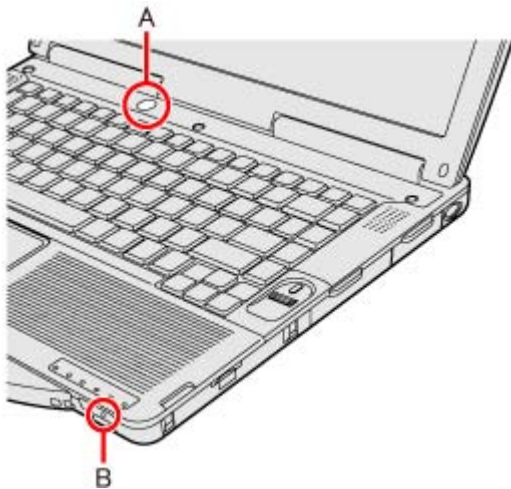

<CF-52 Series>

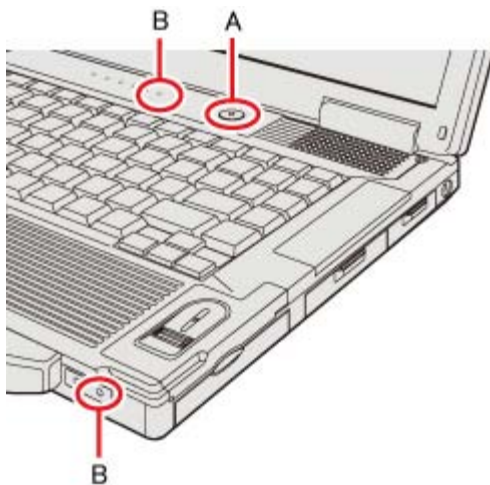

- You can alternatively use the Windows menu to enter sleep^{*3} or hibernation.

Windows 7

Click  (Start) -  - [Sleep] / [Hibernate].

Windows XP

To enter standby, click [start] - [Turn Off Computer] - [Stand By]. To enter hibernation, click [start] - [Turn Off Computer], then press and hold «Shift» and click [Hibernate].

CAUTION

While the computer is entering sleep^{*3} or hibernation

- Do not:

- Touch the keyboard, touch pad, touchscreen (only for model with touchscreen) or power switch.

- Use an external mouse or other peripheral devices.
- Connect or disconnect the AC adaptor.
- Operate the wireless switch.
- Close or open the display.
- Insert and remove the SD Memory Card.

Wait until the power indicator blinks green (sleep^{*3}) or goes off (hibernation).

- **It may take 1 or 2 minutes to enter sleep^{*3} or hibernation. Do not touch any key though the screen becomes dark.**
- **At the beep^{*4}, immediately release the power switch. After releasing the switch, do not operate it until the power indicator blinks or goes off.**

Windows 7

If you press and hold the power switch for longer than 4 seconds, the computer will forcibly shut down and unsaved data will be lost even if you have set [When I press the power button] to any item in [Change what the power button does].

Windows XP

If you press and hold the power switch for longer than 4 seconds, the computer will forcibly shut down and unsaved data will be lost even if you have set any item in [When I press the power button on my computer]. (➡ [Setting Sleep or Hibernation](#))

In sleep^{*3} or hibernation

- **Do not attach or remove peripheral devices. Doing so may cause malfunction.**
- **Power is consumed in sleep^{*3}. Power consumption may increase when a PC Card is inserted. When power is exhausted, the data retained in memory will be lost. Connect the AC adaptor when using the sleep^{*3} function.**
- **Do not turn on/off the wireless switch.**

To resume from sleep^{*3} or hibernation

1. **Open the display, or press the power switch (A).**

<CF-53 Series>

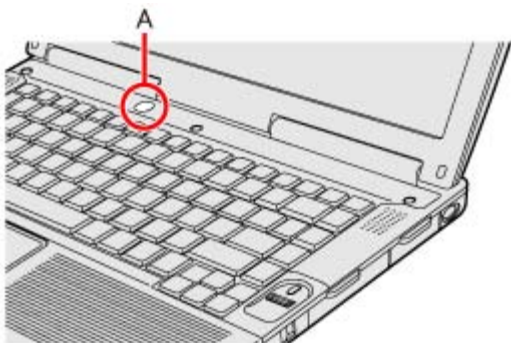

<CF-52 Series>

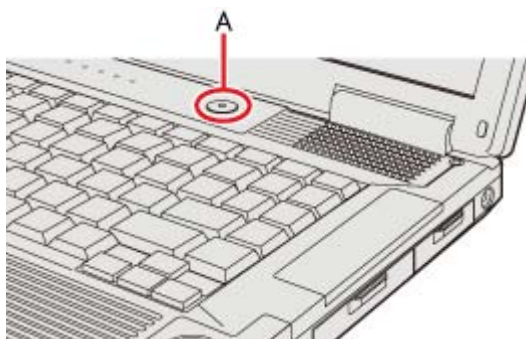

Windows 7

- In the default setting, the Windows password will be requested to resume.

Windows XP

- When [Stand by] or [Hibernate] is selected as the setting for [When I close the lid of my portable computer] (➡ [Setting Sleep or Hibernation](#)), you can resume operation opening the display.

CAUTION

- **Do not perform the following operations until resuming is complete. After the display is resumed, wait approximately 30 seconds (normally) or 60 seconds (when the computer is on a network).**
 - Touch the keyboard (except for password input), touch pad, touchscreen (only for model with touchscreen) or power switch.
 - Use an external mouse or other peripheral devices.
 - Connect or disconnect the AC adaptor.
 - Close or open the display.
 - Shut down or restart Windows.
 - Enter sleep^{*3} or hibernation (Wait approximately 1 minute).
 - Operate the wireless switch.
 - Insert and remove the SD Memory Card.

Windows 7

If the computer enters sleep^{*3} while a USB keyboard or mouse is connected, touching the USB keyboard keys or mouse will resume the computer.

NOTE

- <Only for model with Bluetooth>

After resuming from sleep or hibernation, the message "TosBtMng has stopped working" may appear.

1. Click [Close program].
 2. If Bluetooth connections are cut off, click  (Start)^{*5} - [All Programs] - [Bluetooth] - [Bluetooth Settings], and connect to the Bluetooth devices again.
-
-

*3 : Windows XP: standby

*4 : If the speakers are muted or [Sound] is turned off in [Concealed Mode Configuration], beeps do not sound.

*5 : Windows XP: [start]

Security Measures

Use these features to protect your data.

- **Other security measure**
 - Set [\[Embedded Security \(TPM\)\]](#): For further information, refer to the *Installation Manual of "Trusted Platform Module (TPM)"*.

Setting the Supervisor Password/User Password

Set the Supervisor Password before setting the User Password.

1. **Start up the Setup Utility. (➔ [Starting the Setup Utility](#))**
2. **Select [Security].**
3. **Select [Set Supervisor Password] or [Set User Password], and press «Enter».**
4. **Enter your password in [Create New Password] and press «Enter».**
 - When the password has been set, you need to enter your password in [Enter Current Password] and press «Enter».
 - To disable the password, leave the input field empty and press «Enter».
5. **Enter your password again in [Confirm New Password] and press «Enter».**
6. **Press «F10», and then select [Yes] and press «Enter».**

CAUTION

- **Do not forget your password. If you forget your Supervisor Password, you will not be able to use your computer. Contact Panasonic Technical Support.**
 - **When running the Setup Utility, do not leave and go away from your computer even for a short time, since other people may set or change the password.**
-

NOTE

- **The password will not be displayed on the screen.**
- **You can use up to 32 alphanumeric characters (including spaces).**
 - The case (upper/lower) is distinguished.
 - Use only the upper horizontal row of numeric keys to input your password.

- You cannot use «Ctrl» to input a password.
- **Disabling the Supervisor Password also disables the User Password.**

Preventing Your Computer from Unauthorized Use

You can set a start-up password to protect your computer from unauthorized use.

1. **Set the password (➔ [Setting the Supervisor Password/User Password](#)) , and select [Enabled] in [\[Password On Boot\]](#) in the [\[Security\]](#) menu of the Setup Utility.**

NOTE

- **If the Supervisor Password or User Password has been set, the password input screen will be displayed on starting-up of the Setup Utility even though [\[Password On Boot\]](#) is set to [\[Disabled\]](#).**

Preventing Your Hard Disk Data from Being Read or Written

The hard disk lock function protects the hard disk data from being read or written when the hard disk is attached to another computer. The data can be read/written when the hard disk is returned to the original computer. (Note that the hard disk lock does not guarantee complete protection of the data.)

1. **Select [\[Enabled\]](#) in [\[Hard Disk Lock\]](#) in the [\[Security\]](#) menu of the Setup Utility.**

CAUTION

- **For the data being read/written on the original computer, the Setup Utility settings must be the same as when the hard disk was removed.**
- **You cannot use the hard disk lock function without setting the Supervisor Password. Set the Supervisor Password beforehand (➔ [Setting the Supervisor Password/User Password](#)).**
- **When you have your hard disk drive repaired**
- Contact Panasonic Technical Support.
 - Before sending back the hard disk drive, be sure to set the [\[Hard Disk Lock\]](#) to [\[Disabled\]](#).

NOTE

- **The hard disk lock function works with the built-in hard disk. It does not work with the**

external hard disk.

- We recommend you to set [Password On Boot] to [Enabled] to ensure security though it is not required to enable the hard disk lock.

Disabling CD/DVD Drive

Disable CD/DVD drive operation to prevent the drive from being read/written and from being used to start the computer. You can protect your data from unauthorized access or accidental overwriting.

1. Select [Disabled] in [Optical Drive] in the [Advanced] menu of the Setup Utility.

NOTE

- This does not work for USB CD/DVD drive.
-
-

Using Intel® Identity Protection Technology (Intel® IPT)

Intel® IPT is a function built into the PCs with the 2nd generation Intel® Core™ vPro™ processor family and Intel® Core™ processor family mounted. With Intel® IPT, a six-digit One-Time Password is generated every 30 seconds. Using this One-Time Password can perform two-factor authentication to prevent unauthorized access. Thus, stronger authentication is enabled. To use Intel® IPT, a dedicated solution or application software provided by a service provider is required. To check if such application software is installed, do the following.

Windows 7

Click  (Start) - [Control Panel] - [Uninstall a program].

Windows XP

Click [start] - [Control Panel] - [Add or Remove Programs].

If [Intel(R) Identity Protection Technology x.x.x.x] is displayed, the software has been installed. Otherwise, install the software in the following steps.

1. Log on to Windows as an Administrator.

2.

Windows 7

Click  (Start) and input "c:/util/ipt" in [Search programs and files], and press «Enter».

Windows XP

Click [start] - [Run] and input "c:/util/ipt", and click [OK].

3. Double-click [install] in the "ipt" folder.

For information about the using method, contact the service provider.

Battery Power

Important Battery Tips

How to use the battery with minimal deterioration

The battery is a consumable and, as such, its performance will gradually deteriorate. This deterioration is accelerated under the following conditions.

- **When the battery is repeatedly charged**
- **When the battery is used, charged or stored in a place with high temperature**

To minimize deterioration of the battery and ensure a longer battery life, you must reduce the number of charges and ensure that the temperature inside the battery does not become too high. Bear in mind the following points.

Charge the battery in a temperature range of 10°C to 30°C {50°F to 86°F}

In places where the outside air temperature is high, the temperature inside the battery will also become high. Do not charge the battery inside a vehicle with all its windows closed and exposed to the hot sun or in other places where the temperature is high.

This computer's battery will not be charged if its temperature is outside the allowable range. (At such a time, the battery indicator blinks orange.)

We recommend charging the battery no more than once per day

Recharging the battery after every small use raises the total number of battery charges and speeds battery deterioration.

To lower the total number of battery charges, we recommend recharging the battery no more than once per day or when the remaining charge drops to 10% or less.

With this computer, in order to reduce the number of charges, the battery will not be recharged immediately after it has been fully charged unless the remaining charge has fallen to less than 95%.

Charging the battery while the computer is powered off is recommended

If the computer's power is on, the temperature inside the battery rises due to the effects of heat from the CPU and other components. We recommend that you only charge the battery when the

computer is powered off.

Use the battery in the high temperature mode

High temperature mode is a function that prevents deterioration of the battery in high temperature environments or when using the fully charged battery pack for a long period of time.

When the high temperature mode is selected, the battery capacity is reduced, and therefore the battery operating time is shorter.

We recommend the high temperature mode setting when the computer is to be used under the following conditions:

- **When the computer is to be used in a vehicle**
- **When the computer is to be used in a place with high temperature**
- **When the computer is to be used for extended periods of time with the AC adaptor connected**
- **When battery operation is not required for long hours (When the battery's remaining capacity does not often drop to 40% or below in normal temperature mode)**

How to use the computer to maximize the battery operation time

Leave the computer off when it is not in use

Decrease the internal LCD brightness by pressing «Fn» + «F1»

Pressing «Fn» + «F1» will lower the degree of brightness, thereby reducing the power consumption.

Before stepping away from your computer, press «Fn» + «F7» or «Fn» + «F10» to put your computer in the sleep^{*1} or hibernation mode

Pressing these key combinations will put your computer in the sleep^{*1} or hibernation mode, thereby lowering the power consumption.

*1 : Windows XP: standby

Windows 7

Click  or  in the notification area, and select a power plan that uses the power-saving function.

Windows XP

Click [start]² - [Control Panel] - [Performance and Maintenance] -[Power Options], and select the desired power-saving setting

If no power plan that uses the power-saving function is shown, click [More power options] and then click [Change plan settings] for the power plan you want to modify. Then change the power-saving settings.

2 : Depending on the setting, [Start] may be displayed.

We recommend against using applications or screen saver that place a significant load on the CPU

Some screen savers place a large load on the CPU. When using these screen savers, a significant load is placed on the CPU even when the computer is not being used. We recommend that you do not use screen saver that will drain the CPU.

Remove peripheral devices (USB devices, PC Cards, external mouse, etc.) when not in use

When the computer is not going to be used for an extended period (a month or more)

In order to maintain the battery performance, remove the battery with a remaining charge of 30% to 40% from the computer, and store it in a cool, dark place

If the battery pack is kept installed in the computer, it will discharge gradually even when the computer's power is off. If this condition continues for a long period (several months or more), the battery may overdischarge, causing its performance to deteriorate. In addition, this deterioration will accelerate if the battery pack is stored inside a vehicle with all its windows closed and exposed to the hot sun or in other places where the temperature is high. Store the battery pack where the temperature is within the range of 10°C to 30°C {50°F to 86°F}.

Things to keep in mind when using the battery pack

Bear in mind the following points when installing and removing the battery pack

- **Do not install or remove the battery pack while the computer is in the sleep/standby mode. Removal of the battery pack in this mode cause the data to be erased and cause the computer to malfunction.**
- **Do not touch the terminals on the battery pack.**

If the terminals are dirty or damaged, the battery may not function properly or the computer may not operate properly.

Charging time and discharging time differs depending on the computer's power status and temperature

- It takes longer to fully charge the battery when the computer's power is on. To charge the battery more quickly, power the computer off, or put it in the standby or the hibernation mode.
- It takes longer to fully charge the battery in low temperature environments. The battery discharges more quickly in low temperature environments.

Battery Indicator

Battery indicator	Battery status
Not lit	The battery pack is not inserted or not being charged.
Orange	Charging is in progress.
Green	The battery is fully-charged.
Blinking green	In High temperature mode , the battery pack is discharging the power to 80% ^{*4} of the normal temperature mode. Do not remove the battery pack in this status.
Red	The remaining battery is approximately 9% or less.
Blinking red	The battery pack or the charging circuit is not operating properly.
Blinking orange	The battery cannot be charged temporarily due to the following reasons: <ul style="list-style-type: none"> • Its internal temperature is out of the acceptable range. • The power supply is not enough because software applications or peripheral devices are consuming a large amount of power.

*4 : In high temperature mode, the 100% battery level is equivalent to 80% level of the normal temperature mode.

NOTE

- Once the battery is fully charged, the computer performs recharging only when the battery level becomes less than approximately 95%, so overcharging is avoided.
- When **[LED]** is set to **[OFF]** on the **[Concealed Mode Configuration]** menu, LED disappears.

Checking the Remaining Battery Charge

You can check the remaining battery charge on the screen.

(After logging on to Windows)

1. Press «Fn» + «F9».

- When the battery pack is inserted (example)

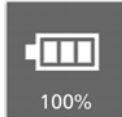

: Normal temperature mode



: High temperature mode

- When the battery pack is not inserted



NOTE

- The battery display may not correspond to the actual remaining battery charge in the cases as below. To correct the display, perform the Battery Recalibration (→ [Correcting the Battery Display \(Battery Recalibration\)](#)).

- The battery indicator remains red.
- The indicator lights orange and the display shows 99% for a long time.
- Low battery warning appears soon after a short time of use.
This can occur when the computer is in sleep^{*5} for a long time without power supply from the AC adaptor.

- The battery display may not be the same as that of notification area^{*6}. This is not a malfunction.

*5 : Windows XP: standby

*6 : Windows XP: Or of [Power Meter] in [Power Options Properties]

High temperature mode

The high temperature mode can prevent the battery from deteriorating when the computer is used in high-temperature environment or used for a long time with its battery fully charged.

Select [Auto] (default) or [High Temperature] in [Environment] of the [Main] menu of the Setup Utility.

NOTE

- Note that a level corresponding to a 100% charge for high temperature mode is approximately equivalent to an 80% charge level for normal temperature mode.
- After switching from [Normal Temperature] to [High Temperature] or vice versa, the remaining battery capacity will not be displayed correctly until the battery pack is completely discharged or fully charged.
- In the [Auto] mode:
Once the computer has automatically switched from the normal temperature mode to the high temperature mode, the computer will not switch back to the normal temperature mode until the battery has been used and recharged to a total charge level of about 5 times as much as that of the fully-charged state. This is to avoid battery deterioration.

Computer behavior with low battery

The default settings are as follows.

When the battery level becomes 10% [Low battery alarm]	When the battery level becomes 5% [Critical battery alarm]
<ul style="list-style-type: none"> • Displays a message that the battery level is low. 	<p>Windows 7</p> <ul style="list-style-type: none"> • The computer enters hibernation. <p>Windows XP</p> <ul style="list-style-type: none"> • Displays a message that the battery level is low, and then the computer enters hibernation.
↓	↓
Charge the battery.	Connect the AC adaptor or replace the battery to start up the computer.
<ul style="list-style-type: none"> • Connect the AC adaptor immediately. If you do not have the AC adaptor, exit the running programs and Windows, then confirm that the power indicator is off. • If you have a fully charged 	<ul style="list-style-type: none"> • Connect the AC adaptor and charge the battery. • If you have a fully charged spare battery, turn off the computer, replace the battery and turn the computer on again. <p>Windows 7</p> <p>When the computer enters hibernation with the</p>

spare battery, turn off the computer, replace the battery and turn the computer on again.

battery down and you resume the operation without charging the battery, the Windows Resume Loader starts up. Follow the on-screen instructions. After that, however, Windows may not start up normally, or the [Low battery level]/[Critical battery level] function may not work normally.

Windows XP

When the computer enters hibernation with the battery down and you resume the operation without charging the battery, Windows may not start up normally or the alarm function may not operate normally from then on.

Correcting the Battery Display (Battery Recalibration)

The "Battery Recalibration" function measures and memorizes the battery capacity. To correct the battery display, use this function to fill the battery and then discharge it completely. Perform the procedure at least once immediately after purchasing the computer. Normally the interval of battery recalibration is 3 months. The battery display may not be correct when the battery pack deteriorates after a long time use. In this case, perform the procedure again.

1. Connect the AC adaptor.

2. Close all the applications.

3. Perform "Battery Recalibration".

1. Click  (Start)^{*7} - [All Programs] - [Panasonic] - [Battery] - [Battery Recalibration].
2. When the confirmation message appears, click [Start].
 - Frequent recalibration of the battery can degrade the battery. A caution message appears when the battery recalibration is performed at the shorter interval than approximately a month. In this case, cancel the battery recalibration.
3. When the message requests shut down of Windows, click [Yes].

The battery recalibration starts.

After the battery pack is fully charged, discharging starts. When the discharging is completed, the power goes off automatically.

After the battery recalibration is finished, normal charging starts.

^{*7} : Windows XP: [start]

NOTE

- **The temperature range should be 10°C to 30°C {50°F to 86°F}.**
 - **The battery recalibration may take a long time due to the large battery capacity. This is not a malfunction.**
 - Full charge: Approximately 2 hours (with CF-VZSU71U)/1.5 hours (with CF-VZSU72U)
 - Complete discharge: Approximately 2 hours (with CF-VZSU71U), 1.5 hours (with CF-VZSU72U)
 - **If the computer is turned off during the battery recalibration (e.g., due to power failure, or accidental removal of the AC adaptor and battery pack), the battery recalibration will not be completed.**
 - **You can also perform the battery recalibration with the following procedure.**
 1. Restart the computer.
 2. Press and hold «F9» while the [Panasonic] boot screen is displayed just after the computer starts the startup procedure.
 3. When the remaining battery capacity is displayed, press «Enter».
 4. Follow the on-screen instructions.
-
-

Replacing the Battery Pack

The battery pack is a consumable item so the replacement will be necessary. If the battery operation time becomes noticeably short and not recovered even after recalibrating the battery, replace with a new battery.

CAUTION

- **The battery pack is not charged when you first purchase it. Be sure to charge it before using for the first time. Charging starts automatically when the AC adaptor is connected to the computer.**
 - **Use only the specified battery pack with your computer.**
 - **In sleep^{*8}, do not remove/replace the battery pack. Otherwise your data will be lost and the computer may be damaged.**
-

1. **Turn off the computer.**
 - Do not use the sleep^{*8} function.
2. **Reverse the computer and remove the cover.**
 1. Press and hold the  mark part (A) and slide the cover to remove.

<CF-53 Series>

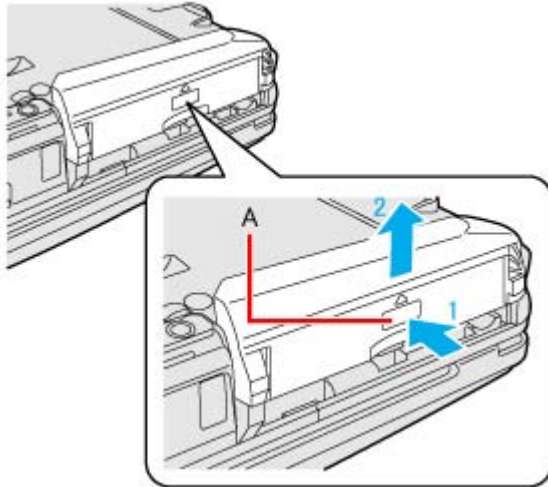

<CF-52 Series>

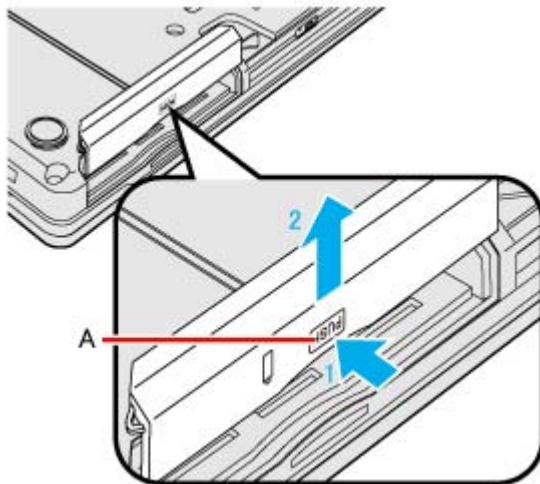
**3. Remove/Insert the battery pack.**

- To remove

Slide and hold the latch (B), and pull the tab (C) of the battery pack.

<CF-53 Series>

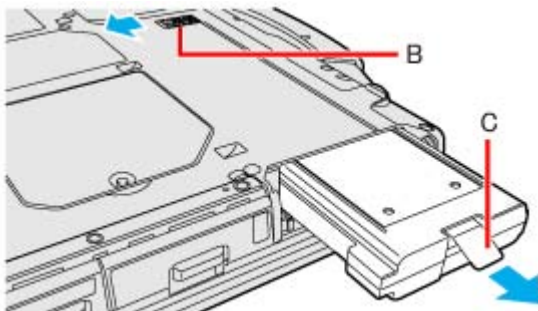

<CF-52 Series>

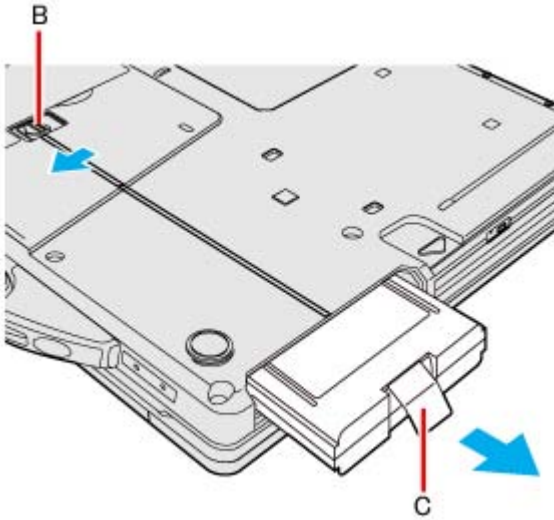

- To insert
Insert the battery pack until it securely fits the connector.

<CF-53 Series>

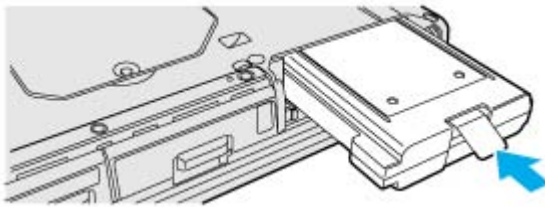

<CF-52 Series>

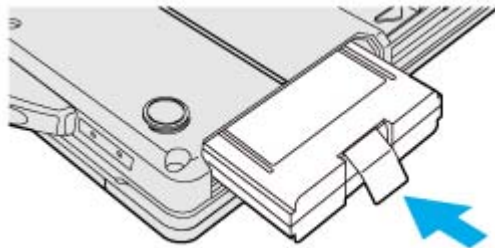

4. Slide the cover back.

Push the cover until it clicks.

<CF-53 Series>



<CF-52 Series>



CAUTION

- **Make sure the latch is securely locked, otherwise the battery pack may fall when you carry the computer.**
 - **Do not remove the battery pack forcibly when the latch is locked. Doing so may damage the battery pack.**
-

*8 : [Windows XP: standby](#)

CD/DVD Drive

NOTE

- Connect the AC adaptor if writing operation takes a long time. If the remaining battery power becomes low and the power is not supplied, writing operation may not be completed.
 - You need to use writing software to write to discs (e.g. [Using Roxio Creator LJB](#)). Ensure the disc is compatible with the selected writing speed.
Windows 7
You can also use Windows features to write to discs (➔ [Using Windows Feature](#)).
 - The quality of written data depends on the disc.
-

Handling Precautions

CD/DVD drive handling care

- Do not expose the CD/DVD drive to excessive smoke that may leave a residue, e.g., oil smoke, or tobacco smoke. Doing so can shorten the life of the drive lens.
- We recommend cleaning the drive lens with an air puffer used for camera lenses. (Do not use any spray-type of lens cleaning products.)

When opening/closing the tray

- When the computer is on, use the eject button (➔ [Inserting/Removing a Disc](#)) or eject through Windows.
- When inserting or removing a disc, be careful not to touch the lens and other parts of the laser pickup.
- Do not leave the tray open and do not touch the lens.
The lens and disc can become dusty in some conditions. It may cause malfunction in reading or writing.
- Do not apply excessive force to the tray in the open position.
- Never insert a foreign object such as a paper clip into the CD/DVD drive.
Doing so may cause malfunction.

- **Do not place items other than discs on the tray.**
- **Do not access the drive until after the tray is closed.**
- **Set this computer on a horizontal plane.**

While the CD/DVD drive is being accessed

- **Do not open the CD/DVD drive or move the computer while the CD/DVD drive is being accessed. Doing so could cause the disc to shift position and this may damage the disc, or cause the CD/DVD drive to malfunction. In addition, after running an application involving access to a disc, close the application before opening the CD/DVD drive.**
- **Set this computer on a horizontal plane.**

Disc handling care

- **Do not use deformed, warped, or irregularly shaped discs.**
Reading of disc may not be possible depending on the disc conditions (cracks, dirt, modification, data recording quality, copy protection, recording equipment/software that was used to create the disc, etc.)
- **Before using a disc, carefully read the operating/handling instructions and package of the disc.**
- **If the discs are not handled appropriately, they may become dirty or scratched. Furthermore the writing speed may get slower and the data may not be correctly written on or read from the disc. Other damage may cause a drive failure.**
- **Note the following precautions.**
 - Do not touch the disc surface (the side with no printing).
 - Keep the disc surface clean and free from dirt, dust, fingerprints and scratches.
 - Do not write on the surface of the disc with a ballpoint pen or other writing instrument.
 - Do not attach stickers to discs.
 - Do not drop, bend, or place heavy objects on top of discs.
 - Do not place or store discs in locations exposed to heat, direct sunlight, humidity or dust.
 - If a disc is brought from a cold to a warm location, condensation may form on the disc. For read-only discs, wipe off the condensation using a soft, dry, lint-free cloth before using the disc. For recordable/rewritable discs, wait until the condensation dries.
 - When not using discs, keep them in their protective cases or cartridges.

To clean discs

<For read-only discs>

Wipe discs with a dry, soft cloth from the center toward the edge. If discs get very dirty, wipe with a moist, soft cloth from the center toward the edge, then wipe again with a dry cloth to take up remaining moisture.



<For recordable/rewritable discs>





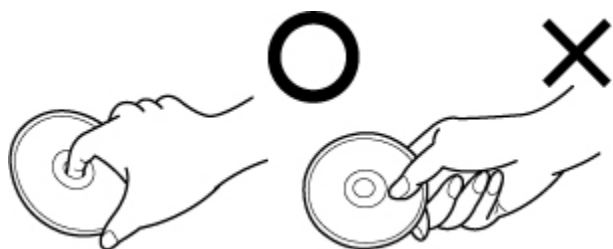



Use the disc for recordable/rewritable discs cleaner to clean these discs. Do not use a cloth, CD cleaners or any other such cleaners under any circumstances.

How to hold a disc



Disc Information

- You can read from/write to the following discs.

CD-R	CD-RW		
			
DVD-RAM*1	DVD-R	DVD-R DL	DVD-RW*2
			
+R	+R DL	+RW	







*1 : DVD-RAM: Only non-cartridge type or removable cartridge type can be used.

*2 : Does not support DVD-RW Ver.1.0.

- You can read from the following discs.

CD-ROM	CD DIGITAL AUDIO	CD TEXT
		

CD-EXTRA	Video CD	Photo CD
		

DVD-ROM	DVD-Video
	

Recommended discs for writing

CD-R

TAIYO YUDEN Co., Ltd.

CD-RW/High-Speed CD-RW

MITSUBISHI KAGAKU MEDIA CO., Ltd.

Ultra-Speed CD-RW

MITSUBISHI KAGAKU MEDIA CO., Ltd.

DVD-R

Panasonic Corporation

MITSUBISHI KAGAKU MEDIA CO., Ltd.

TAIYO YUDEN Co., Ltd.

DVD-R DL

MITSUBISHI KAGAKU MEDIA CO., Ltd.

TAIYO YUDEN Co., Ltd.

DVD-RW

MITSUBISHI KAGAKU MEDIA CO., Ltd.

Victor Company of Japan, Limited

DVD-RAM

Panasonic Corporation
HITACHI MAXELL, Ltd.

+R / +RW

 MITSUBISHI KAGAKU MEDIA CO., Ltd.

High Speed +RW

 MITSUBISHI KAGAKU MEDIA CO., Ltd.

+R DL

 MITSUBISHI KAGAKU MEDIA CO., Ltd.

DVD discs you can use for writing

DVD-R for General

 1X-SPEED (4.7 GB)
 1-2X-SPEED (4.7 GB)
 1-4X-SPEED (4.7 GB)
 1-8X-SPEED (4.7 GB)
 1-16X-SPEED (4.7 GB)

DVD-R DL

 2-4X-SPEED (8.5 GB)
 2-8X-SPEED (8.5 GB)

DVD-RW

 1X-SPEED (4.7 GB/9.4 GB)
 1-2X-SPEED (4.7 GB/9.4 GB)
 2-4X-SPEED (4.7 GB/9.4 GB)
 2-6X-SPEED (4.7 GB/9.4 GB)

DVD-RAM

 2X-SPEED (4.7 GB/9.4 GB)
 2-3X-SPEED (4.7 GB/9.4 GB)
 2-5X-SPEED (4.7 GB/9.4 GB)

+R

 1-2.4X-SPEED (4.7 GB)
 1-4X-SPEED (4.7 GB)
 1-8X-SPEED (4.7 GB)
 1-16X-SPEED (4.7 GB)

+R DL

 2.4X-SPEED (8.5 GB)
 2.4-8X-SPEED (8.5 GB)

+RW

 1-2.4X-SPEED (4.7 GB)
 1-4X-SPEED (4.7 GB)

High-Speed +RW

 3.3-8X-SPEED (4.7 GB)

Using DVD Media

To play DVD-Video, you need to use DVD playback software such as [WinDVD](#).

Region code setting

DVD-Video is allocated to region codes according to where they are sold. To play the DVD-Video, the player's software and the drive must have the corresponding region code.

e.g., For U.S.A. and Canada: "1" / For Europe: "2"

- **The region code of the drive is not set at purchase. The operation depends on the DVD-Video that is first played.**
 - **DVD-Video with a specific region code:**
The drive will automatically be set at the same region code as the DVD-Video.
 - **DVD-Video with multiple region codes:**
[Confirm Region] appears. Select the region code and click [OK]. Play now begins.

CAUTION

- **You can change the region code setting up to 5 times including the initial setting. Be extremely careful because you cannot change the region code anymore after the fifth change, even if you reinstalled the operating system.**
 - **Any problem resulting from illegal changing or altering of the region code is the user's responsibility.**
-
-

NOTE

- **[Confirm Region] appears when the DVD-Video has only 1 region code and the drive is set for another region code. ([Confirm Region] may not appear with some DVD-Video discs. To check the current region code and the number of remaining times of changing the code, right-click on the WinDVD screen and click [Setup] - [Region].)**
-
-

Inserting/Removing a Disc

1. Turn on the computer.
2. Press the eject button (A) and slowly pull out the tray.

<CF-53 Series>

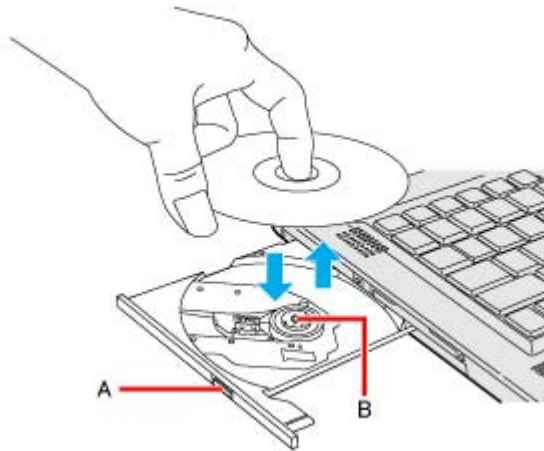

<CF-52 Series>

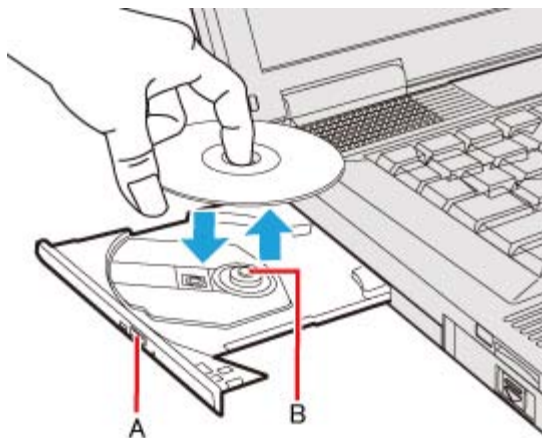

3. Insert/Remove a disc.

- To insert
Set the disc with the label side up and press the center of the disc until it clicks in place.
- To remove
Press on the center spindle (B) and carefully lift up the edge of the disc.

4. Close the tray.

Do not press the eject button.

NOTE

- To remove a disc when the computer is powered off, insert a pin of 1.3 mm {0.05± in diameter} into the emergency hole (C). (When the diameter of the pin is smaller than this, insert the pin slightly downward.) Pushing it to the end allows the tray to come out.

<CF-53 Series>

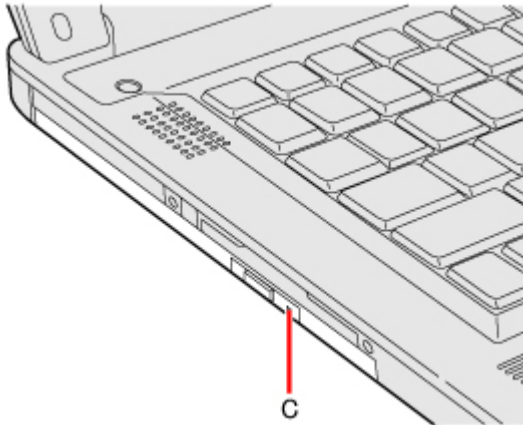

<CF-52 Series>

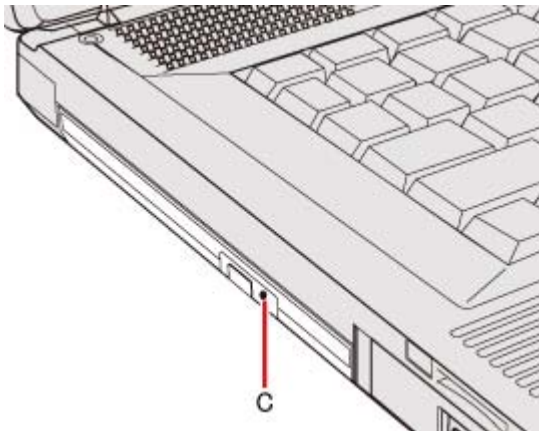

- For AutoPlay CD/DVD:

- If an AutoPlay CD/DVD does not start after the computer resumes from sleep^{*3} or hibernation, remove the disc from the drive and then reinsert it after waiting 15 seconds.
- An AutoPlay CD/DVD may start during file access depending on the status of the disc.

- When playing back motion video from a disc, playback may not be smooth in some conditions.

*3 : [Windows XP: standby](#)

Power-saving mode

If the CD/DVD drive is not accessed for 30 seconds, the drive motor will automatically be shut down to reduce the power consumption. When the CD/DVD drive is accessed again, the drive motor is turned on. In this case, reading of the disc data will take approximately 30 seconds.

Changing the CD/DVD Drive Letter

You can change the drive letters for the CD/DVD drive.

NOTE

- Change the drive letters before installing applications.

1. **Windows 7**

Click  (Start) - [Control Panel] - [System and Security] - [Administrative Tools], and double-click [Computer Management].

- o A standard user needs to enter an administrator password.

Windows XP

Click [start] - [Control Panel] - [Performance and Maintenance] - [Administrative Tools], and double-click [Computer Management].

2. Click [Disk Management] from [Storage].
3. Right-click the hard disk partition or the CD/DVD drive name, and click [Change Drive Letter and Paths...].
4. Click [Change...].
5. Click [Assign the following drive letter] and select the new drive letter, and then click [OK].
At the confirmation message, click [Yes].

WinDVD

WinDVD is a software application for DVD playback. For further information, refer to the software's online manual.

- **DVD-Audio cannot be played back using WinDVD.**
- **Video Codecs within WinDVD installed in this computer cannot be available from an application such as Media Player.**

Running WinDVD

1. Double-click on the desktop.

- Alternatively click  (Start)^{*1} - [All Programs] - [Corel] - [WinDVD for Panasonic].

*1 : Windows XP: [start]

To access the online manual

After starting WinDVD, perform either of the following procedures.



- Click  on the WinDVD control panel and click [Launch Help].

SUPPORT INFORMATION

If WinDVD does not operate properly, we recommend carefully reading the online help file first for problems with the operating environment or operations.

If you still cannot troubleshoot the problem, enter the required information in the inquiry form on the homepage (<http://apps.corel.com/lp/ivi/>), and submit the form.

CAUTION

- **Do not start WinDVD while the drive indicator  is blinking immediately after the computer is turned on.**
- **While WinDVD is running, do not:**
 - Enter sleep^{*2} or hibernation.
 - Switch the display mode by pressing «  » + «P»^{*3} or «Fn» + «F3».
- **During motion video playback, do not:**
 - Eject the disc.
 - Use other applications or the Command Prompt.

- Change the settings of the screen properties.
 - **Do not install another player software together with WinDVD. Doing so may interfere with smooth playback. Some DVD-Video discs contain the player software and start installing. In this case, cancel the installation as soon as possible. If you accidentally installed another player software and find a problem in playback, try either of the following procedures.**
 - Uninstall the player software with the following procedures. (Refer to the instruction manual for the name of player software.)
 - Windows 7**
 1. Click  (Start) - [Control Panel] - [Uninstall a program].
 - Windows XP**
 1. Click [start] - [Control Panel] - [Add or Remove Programs].
 - Set WinDVD as the playback software if you can select the option in the player software settings.
-

*2 : Windows XP: standby

*3 : Windows 7 only

DVD Discs Created Using a DVD Recorder

- Playback may not be possible depending on the DVD recorder or the discs.
- You must finalize ^{*4} DVD-R, DVD-R DL, DVD-RW, +R, +R DL, and +RW before playback. For further information, refer to the instruction manual of the DVD recorder.
- **Windows XP**

You cannot play discs protected with copyright management technologies such as CPPM (Content Protection for Prerecorded Media) and CPRM (Content Protection for Recordable Media).

*4 : A process that enables the playback of the discs on other DVD players, etc.

Writing to CD/DVD

Applicable Media

- Refer to the [Disc Information](#).
- Refer to the software's online manual (below).

About Copies

When writing to discs, make sure that you are not infringing upon any copyrights. It is illegal to copy audio CDs for non-personal use.

When backing up software, make sure that you are not infringing upon any software copyrights for that product.

Using Windows Feature **Windows 7**

1. Insert a disc you can use for writing.
2. In the [AutoPlay] screen, click [Burn files to disc].
 - Alternatively you can click  (Start) - [Computer], and double-click [DVD RW Drive].
 - Follow the on-screen instructions.

Using Roxio Creator LJB

"Roxio Creator LJB" is a CD/DVD recording software application developed by SONIC Solutions. For further information, refer to the software's online manual (below).

1. Click  (Start)^{*1} - [All Programs] - [Roxio] - [Roxio Creator LJB for Panasonic].

*1 : Windows XP: [start]

CAUTION

- If you format a disc using Windows functions, you cannot write with Roxio Creator LJB.

Do not format a disc using Windows functions when you write to the disc using Roxio Creator LJB. For rewritable discs (i.e. CD-RW, etc.), writing is possible using Roxio Creator LJB if all the disc contents are deleted.

- If you set an unused disc in the CD/DVD drive, [AutoPlay] screen may appear and then Windows format screen may be displayed. Do not format the disc when you use Roxio

Creator LJB.

When you write to the disc using Roxio Creator LJB, start Roxio Creator LJB before setting the disc. Windows format screen will not be displayed, which prevents the disc from being mistakenly formatted.

To access the online manual

1. After starting Roxio Creator LJB, click [Help] - [Help].

Usage Precautions

When an external CD/DVD drive has been connected

Do not turn the CD/DVD drive power off on this computer when writing to a disc in an external CD/DVD drive. Turning the power off may result in a malfunction, such as an interruption in the external CD/DVD drive operation.

Using DVD-RAM for Windows 7 Windows 7

Formatting must be executed to write a file to a DVD-RAM. It is possible to write a file to a formatted DVD-RAM in the same way as writing a file to a floppy disk or hard disk.

Format type

There are following types of DVD-RAM formats, as shown below. We recommend that you choose the format type depending on the application.

Format	Feature
FAT32	This format is supported by Windows 95 (OSR2) / 98 / Me / 2000 / XP / Vista / 7. DVD-RAM discs in FAT32 format cannot be used on Windows 95 (other than OSR2) / Windows NT.
UDF1.02	This format is supported by Windows 98 / Me / 2000 / XP / Vista / 7, and compatible with the Video mode of DVD-ROM / DVD-R / DVD-RW / +R / +RW.
UDF1.50	Standard format for DVD-RAM. Data with large file sizes (video or audio data) can be written at high speed. We recommend this format when using DVD-RAM for storing data.
UDF2.00/2.01	This format is used for DVD video recorders conforming to "Video Recording Standards" as established by the DVD Forum, or for PC recording software conforming to the same standards.

UDF2.5	This format is supported by Windows Vista / 7, and is used for Blu-ray recorders or PC recording software conforming to "Video Recording Standards" as established by the Blu-ray Disc Association. This format cannot be used for DVD recorders conforming to "Video Recording Standards" as established by the DVD Forum, or for PC recording software conforming to the same standards.
--------	---

Formatting method

When formatting is executed, data recorded on the disc is erased. Back up data as required.

1. Set a DVD-RAM in the CD/DVD drive.
2. Close all applications that use DVD-RAM.
3. Click  (Start) - [Computer], right-click the CD/DVD drive and click [Format].
4. Select the settings and click [Start].
 - o When the disc was recorded with Roxio Creator LJB and you want to record using Explorer, remove the check mark from [Quick Format].
 - o It may take long time if you removed the check mark from [Quick Format].
 - o Do not cancel formatting partway. Otherwise the disc may no longer accept writing.

CAUTION

- If you have written using Roxio Creator LJB, you cannot write using other software since the format becomes different. To make this possible, remove the check mark for [Quick format] on the format display and format the disc.

Using DVD-RAM for Windows XP

Writing to DVD-RAM

- Logical formatting must be executed to write a file to a DVD-RAM. It is possible to write a file to a logically formatted DVD-RAM in the same way as writing a file to a floppy disk or hard disk.

If you write using Roxio Creator LJB, because the format is different, it will no longer be possible to write using applications other than Roxio Creator LJB. To enable writing, it will be necessary to select [Quick format] when formatting the disc.

Refer to [Using DVD-RAM disc].

To display:

Click [start] - [All Programs] - [DVD-RAM] - [DVD-RAM Driver] - [Using DVD-RAM disc].

When [DVD-RAM] is not displayed even if you click [start] - [All Programs], install DVD-RAM Driver.

1. Click [start] - [Run] and input [c:\util\drivers\ramdrv\english\setup.exe] and then click [OK].
As for english folder, change to the language you install.
Follow the on-screen instructions.

Logical format type

There are six types of DVD-RAM formats (➡ [Format type](#)). We recommend that you choose the format type depending on the application.

Logical format method

- **Formatting software and drivers required to conduct each type of formatting have been installed on this computer. When formatting is executed, data recorded on the disc is erased. Back up data as required.**
 1. Log on to Windows with the administrator authority.
 2. Set a disc in the CD/DVD drive.
 3. Close all applications that use DVD-RAM.
 4. Click [start] - [All Programs] - [DVD-RAM] - [DVD-RAM Driver] - [DVDForm].
 - When [DVD-RAM] is not displayed even if you click [start] - [All Programs], install DVD-RAM Driver.
Click [start] - [Run] and input [c:\util\drivers\ramdrv\english\setup.exe] and then click [OK]. As for english folder, change to the language you install.
Follow the on-screen instructions.
 5. Click  in [Format Type], and select the format type, then click [Start].
 - [Volume label]
UDF format has been selected, input the volume label. When the volume label is not input, it will be set automatically (UDF year / month / day).
 - [Quick format]
Inspect all sectors on the disc, and execute replacement processing of bad sectors.
Normally, it is not necessary to select this.

CAUTION

- **If you have written using Roxio Creator LJB, you cannot write using other software since the format becomes different. To make this possible, you need to perform the logical format. For further information, see "Using DVD-RAM disc". "Using DVD-RAM disc" is displayed by clicking [Start] - [All Programs] - [DVD-RAM] - [DVD-RAM driver] - [Using DVD-RAM disc].**
-
-

Notes During Use

If you have uninstalled Roxio Creator LJB accidentally

Reinstall it by following the steps below.

Windows 7

1. Click  (Start) and input [c:\util\sonic\emc] in [Search programs and files], and press «Enter».
2. Right-click [setup] in [emc] folder and click [Run as administrator].
If there are two or more "setup" files, double-click the file whose [Type] is [Application].
Follow the on-screen instructions.
 - o A standard user needs to enter an administrator password.

Windows XP

1. Log on to Windows as an administrator.
2. Click [start] - [Run] and input [c:\util\sonic\emc\setup.exe], then click [OK].
Follow the on-screen instructions.

NOTE

- The serial number has been entered beforehand. Do not change the serial number entered. If you have accidentally changed, click [Cancel] to reinstall.

SUPPORT INFORMATION

- **About User Registration**

Follow the steps below for user registration.

1. While connected to the Internet, start up Roxio Creator LJB.
2. Click [Help] - [Register Now] and follow the on-screen instructions.

- **If Roxio Creator LJB does not operate properly, we recommend carefully reading the online help file first for problems with the operating environment or operations. If you still cannot troubleshoot the problem, contact Sonic Solutions.**

URL:

English (U.S.): <http://www.roxio.jp/enu/support/default.html>

English (U.K.): <http://www.roxio.jp/eng/support/Default.html>

French: <http://www.roxio.jp/fra/support/contact/>

German: <http://www.roxio.jp/deu/support/>

Dutch: <http://www.roxio.jp/nld/support/Default.html>

PC Card / ExpressCard

You can insert the following cards.

- **ExpressCard/34 or ExpressCard/54 to the ExpressCard slot (A)^{*1}**
- **PC Card Type I (3.3 mm) or II (5.0 mm) to the PC Card slot (A)^{*2} and (B)**

*1 : Only for model with ExpressCard Slot

*2 : Only for model without ExpressCard Slot

For model without ExpressCard Slot, both of upper slot and lower slot are for PC Card.



NOTE

- The following types of card are not supported:

PC Card Type III (10.5 mm), ZV card, SRAM card, FLASH ROM card (excluding ATA interface type), and other cards that require 12 V of operating voltage.

- Do not start up Windows with a storage type of CardBus PC card attached. An error may occur.

Inserting/Removing the Card

To insert the card

1. **Open the cover (C), and insert the ExpressCard (D)^{*3} or the PC Card (E) with the label side up until it securely fits in to the slot.**
 - For further information, refer to the instruction manual of the card.

*3 : Only for model with ExpressCard Slot

For model without ExpressCard Slot, both of upper slot and lower slot are for PC Card.

<CF-53 Series>

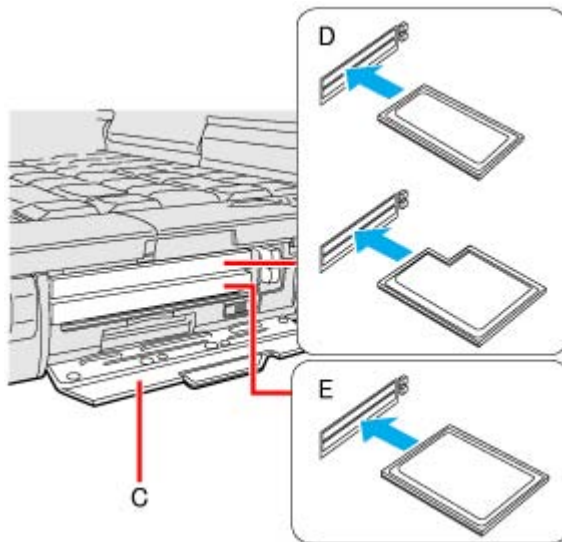

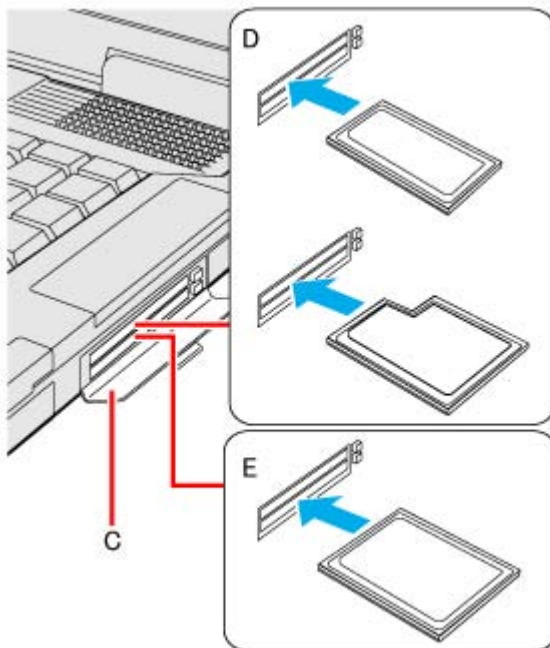

<CF-52 Series>



To remove the card

1. Disable the card function.

Windows 7

1. Click  on the notification area and click .
2. Select the card.

Windows XP

1. Double-click  on the notification area and select the card, then click [Stop].

2. Follow the on-screen instructions.
 - These steps are not necessary when removing the card after turning off the computer.

2. Open the cover and remove the card.

1. Press the eject button (F). The eject button pops out.
2. Press the eject button (F) again so the card comes out of the slot.
3. Draw the card straight out.

<CF-53 Series>

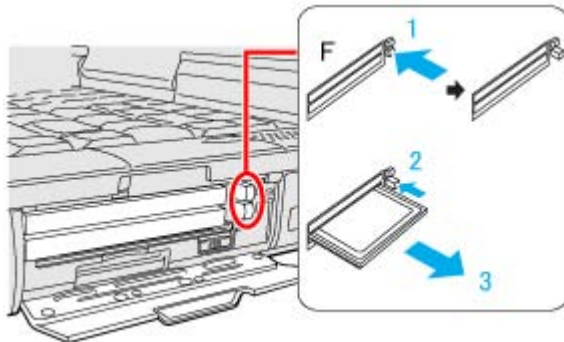

<CF-52 Series>

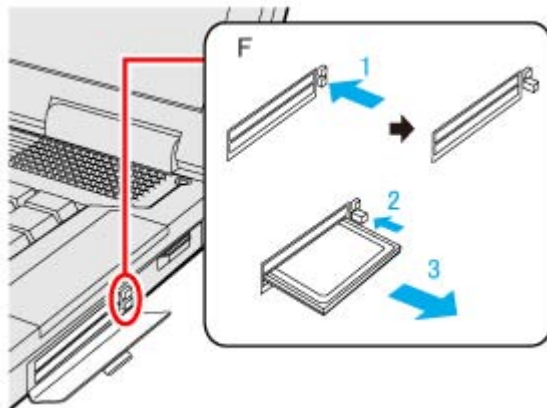

NOTE

- Check the card's specification to prevent the total operating current from exceeding the allowable limit. Otherwise malfunction may occur.
Allowable Current: 3.3 V: 400 mA, 5 V: 400 mA
- Some types of cards cannot be used simultaneously.
- After repeating insertion and removal, some types of card will not be recognized. In this case, restart the computer.
- If the computer freezes after resuming from sleep^{*4} or hibernation, remove and reinsert the card. If the problem persists, restart the computer.

- **When a card is inserted, power consumption increases. Remove the card when it is not in use, especially when operating by battery power.**
 - **To connect peripheral devices (SCSI, IEEE1394, etc.) using a PC Card or an ExpressCard, follow the steps below (one example).**
 1. Connect the peripheral device to the card.
 2. Turn on the power of device.
 3. Insert the card until it surely fits in the slot.
-

*4 : [Windows XP: standby](#)

SD Memory Card

SD Memory Card Information

- The SD Memory Card slot on this computer only accepts SD/SDHC/SDXC Memory Cards*1.
- To format the SD Memory Card on this computer, do not use [Format] of Windows, but use the SD Memory Card format software.
You can download the software from the web site below.
http://panasonic.jp/support/global/cs/sd/download/sd_formatter.html
- To use the SD Memory Card on other devices, format the card on the devices. For further information, refer to the instruction manual of the devices.

*1 : Windows XP : SD/SDHC Memory Cards

Inserting/Removing the SD Memory Card

CAUTION

- Do not remove or insert the SD Memory Card until Windows has completed loading.
 - Do not remove the card or turn off the computer in the following cases, otherwise the data may be corrupted.
 - While the computer is in sleep*2 or hibernation.
 - While the SD Memory Card indicator  is on.
 - While data is being read from or written to the card.
 - Immediately after the writing operation. The computer may still continue the access to the card just after writing operation. If you remove the card before the operation is completed, the data may be damaged or the card access may no longer be performed normally.
 - Note that Panasonic assumes absolutely no liability for any loss of data recorded by the user, or any other damages, direct or indirect.
-

*2 : Windows XP: standby

To insert the card

1. Insert the SD Memory Card with the label side facing up and with the cut corner in front.

<CF-53 Series>

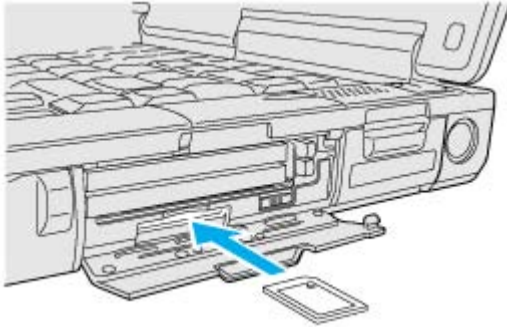

<CF-52 Series>

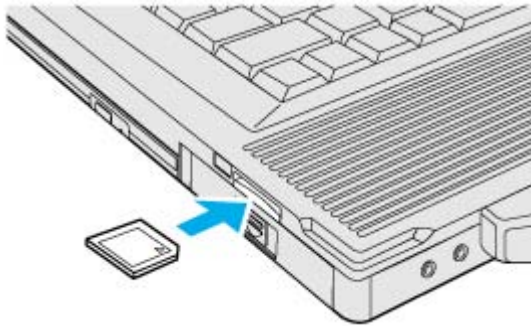

To remove the card

Preparation

- Save the data and close all applications.
- Confirm the SD Memory Card indicator  (A) is off.

<CF-53 Series>

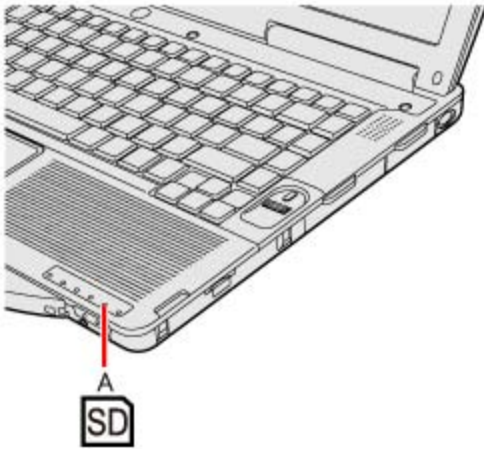

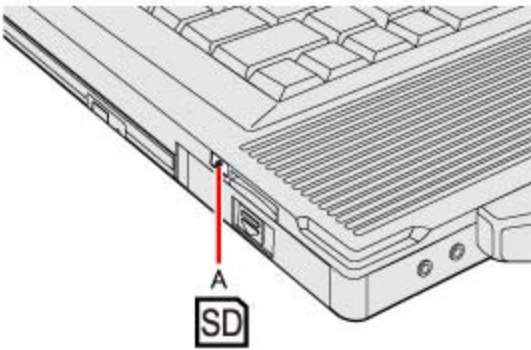

<CF-52 Series>



1. Disable the card function.

Windows 7

1. Click  on the notification area and click .
2. Select the card.

Windows XP

1. Double-click  on the notification area and select the card, then click [Stop].
2. Follow the on-screen instructions.
 - o These steps are not necessary when removing the card after turning off the computer.

2. Remove the card.

1. Press the card so it comes out of the slot.
2. Draw it straight out.

<CF-53 Series>

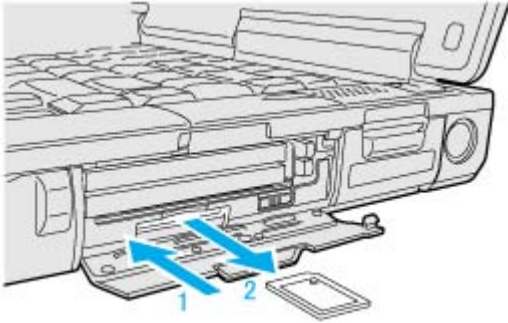

<CF-52 Series>

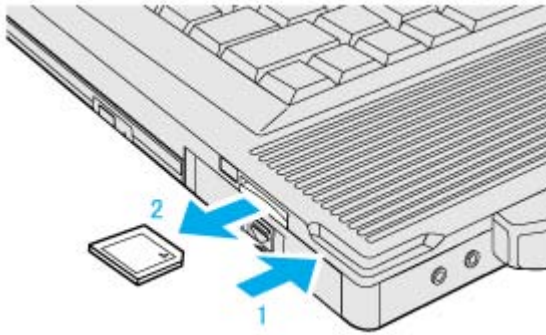

Smart Card

<Only for model with Smart Card slot>

You need software to use a Smart Card.

CAUTION

- Do not:

- Hit, bend, or drop the card.
 - Touch the contact part with fingers or metal object.
 - Place the card in very hot location for a long time.
 - Remove the card immediately after inserting it.
-

Inserting/Removing the Smart Card

To insert the card

1. Insert the Smart Card with the contact part (A) in front.

- Insert the card until it surely fits in the slot.

<CF-53 Series>

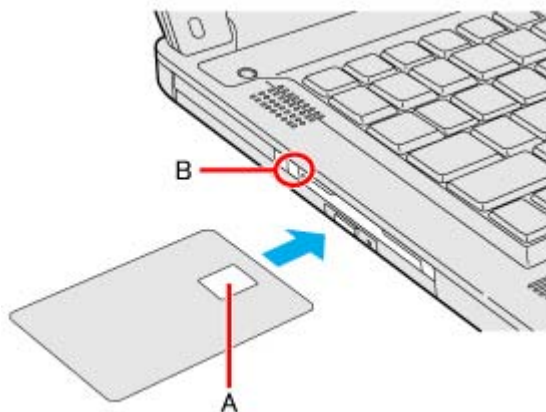

<CF-52 Series>

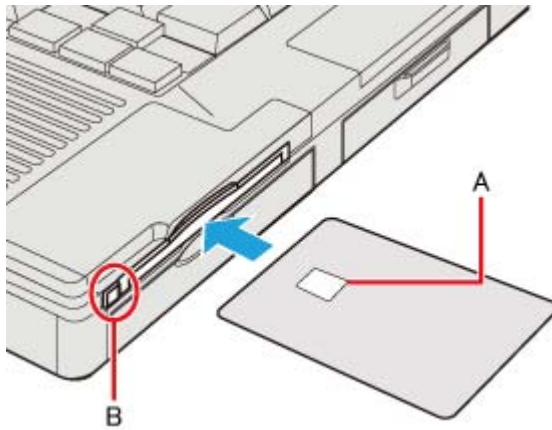

To remove the card

1. **Press the eject button (B).**

The Smart Card pops out.

CAUTION

- Use the eject button to remove the card, otherwise the reading contact may be damaged.

RAM Module

Use RAM modules that comply with the specifications below. Using any other module may cause malfunction or result in computer failure.

RAM module specifications:

204 pins, SO-DIMM, 1.5 V, DDR3 SDRAM, PC3-10600

(For information of RAM module compatibility, contact Panasonic Technical Support.)

CAUTION

- **RAM modules are extremely sensitive to static electricity and can be affected even by static electricity from the human body. When inserting and removing RAM modules, do not touch the terminals or internal components, and do not allow foreign particles to enter the slots. Doing so may cause damage, fire, or electric shock.**
-

Inserting/Removing the RAM Module

This computer has 2 RAM module slots.

- **At purchase, the RAM module is in SLOT: 1.**
- **When using an extra RAM module, insert it in SLOT: 2.**

<CF-53 Series>

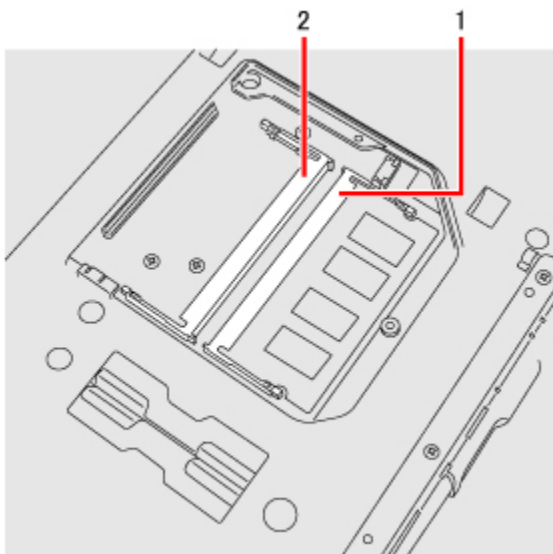

<CF-52 Series>

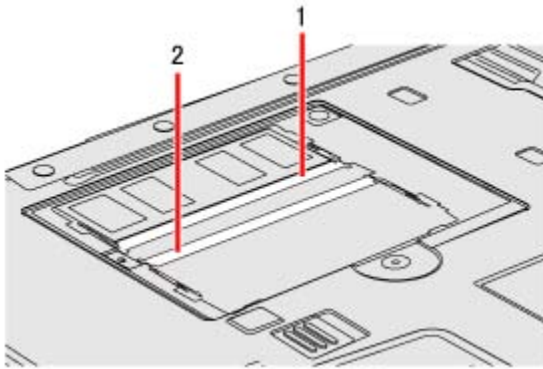
**1. Turn off the computer.**

- Do not use sleep^{*1} or hibernation.

*1 : Windows XP: standby

2. Disconnect the AC adaptor and remove the battery pack (▶ [Replacing the Battery Pack](#)).**3. Remove the screw (A) and the cover on the bottom of the computer.**

<CF-53 Series>

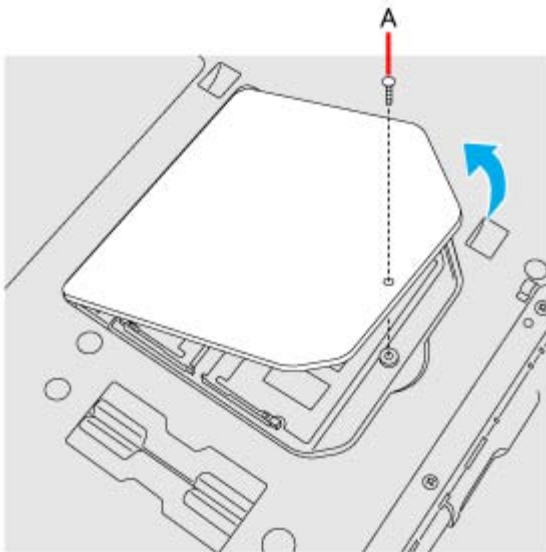

<CF-52 Series>

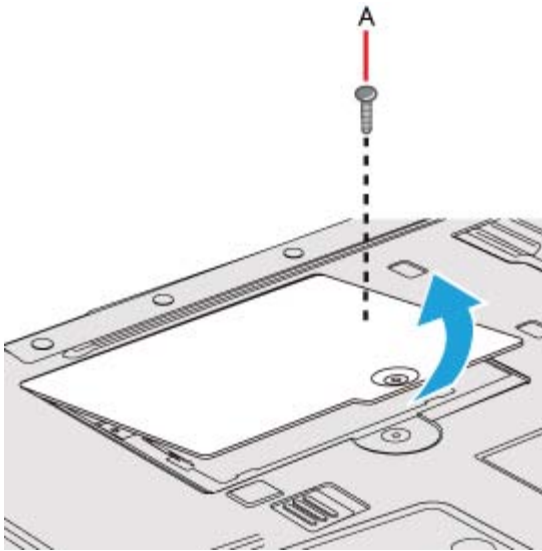

4. Insert/Remove the RAM module.

- To insert

1. Tilt the module slightly and insert it in the slot.
2. Press down the module so that the right and left hooks (B) are locked.

<CF-53 Series>

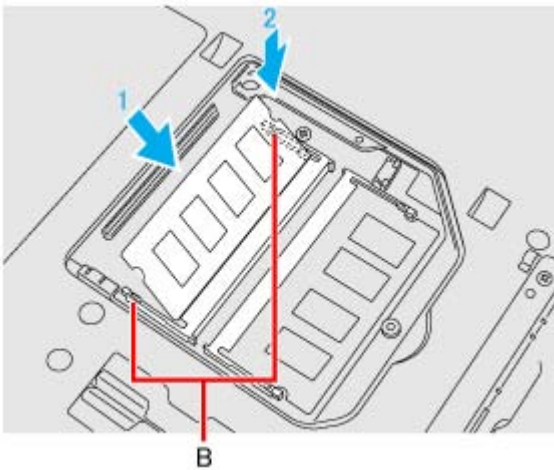

<CF-52 Series>

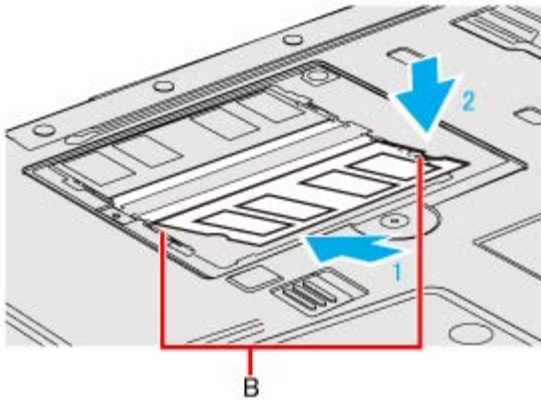

○ To remove

1. Carefully open the right and left hooks (B).
The module will rise.
2. Carefully remove the module from the slot.

<CF-53 Series>

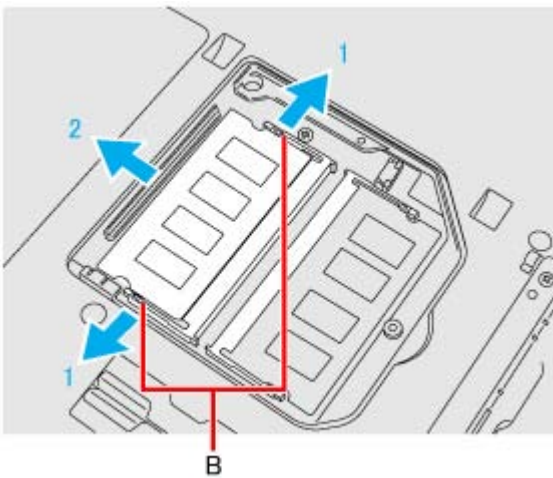

<CF-52 Series>

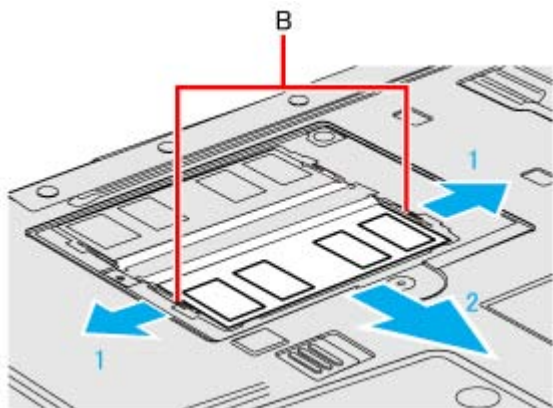

5. Set the cover and battery pack.

CAUTION

- Set the cover correctly and tighten the screw firmly.
-
-

NOTE

- If it is hard to insert or to press down the RAM module, do not try forcibly but check the module's direction.
 - Use the appropriate screw driver so as not to strip the thread of screw.
 - If the RAM module is recognized correctly, the total size of the main unit memory and RAM module memory is displayed on the [\[Information\]](#) menu of the Setup Utility. If the RAM module is not recognized, power off the computer and insert it again.
-
-

Port Replicator

You can use an optional port replicator (For CF-53 Series: CF-VEB531/For CF-52 Series: CF-VEB522). This device frees you from being bothered by a lot of cable connections when you carry the computer. It also allows you to connect various peripherals.

Connect the port replicator to the expansion bus connector (A) on the bottom of the computer.

For further information, refer to the instruction manual of the port replicator.

<CF-53 Series>

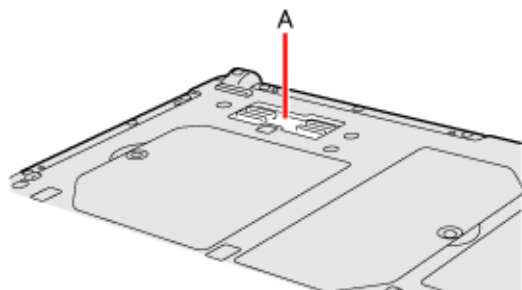

<CF-52 Series>

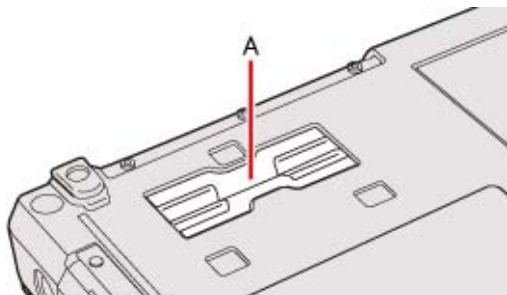

NOTE

- Use only the specified port replicator (For CF-53 Series: CF-VEB531/For CF-52 Series: CF-VEB522).
 - Hot or warm docking/undocking is not possible with the port replicator.
 - To boot the computer from a USB floppy disk drive or a USB CD/DVD drive, be sure to connect the USB drive to the USB port on the computer, not to the USB port on the port replicator.
 - <Only for CF-52 Series>
If you use an external display compatible with "DISPLAY PORT", connect it to a "DISPLAY PORT" on an optional port replicator (CF-VEB522) using a cable compatible with "DISPLAY PORT".
-

External Display

You can switch the output destination to an external analog display or HDMI display. First push down and pull the cover to open the cover.

<CF-53 Series>

Connect the analog display to the VGA port (A).
Connect the HDMI display to the HDMI port (B).

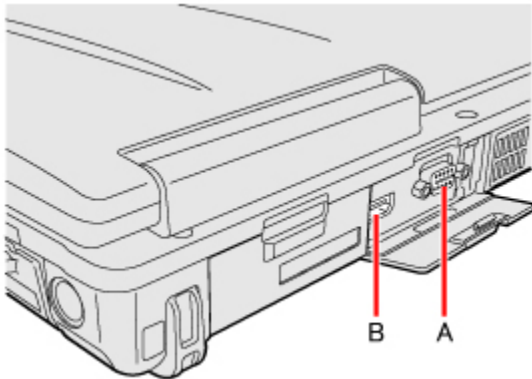

<CF-52 Series>

Connect the analog display to the External Display port (A).

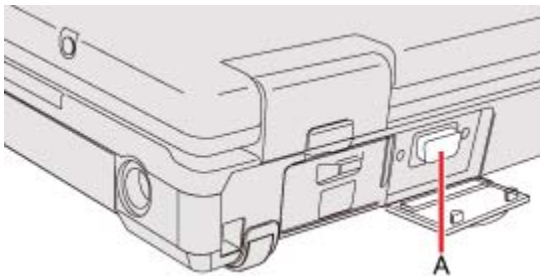

Switching the display mode

Windows 7

1. Press «  » + «P» or «Fn» + «F3».
2. Click the display mode.

Windows XP

1. Press «Fn» + «F3».

Each time you press the key combination:

<CF-53 Series>

LCD → LCD + HDMI display (port replicator side)^{*1} → HDMI display (port replicator side)^{*1} → LCD + HDMI display (computer side) → HDMI display (computer side) → LCD + analog display → analog display → HDMI display (computer side) + analog display → LCD

<CF-52 Series>

Internal LCD → Simultaneous display → External display → Internal LCD

*1 : Only when a port replicator having an HDMI port is connected.

NOTE

- <Only for CF-52 Series>

When an external display is connected to an optional port replicator (CF-VEB522), the display switching may work differently from the above. For further information, refer to the instruction manual of the port replicator.

- After resuming from sleep^{*2} or hibernation, or restarting the computer, the output destination may not be the same as selected in the previous status.
- When you change the display after Windows starts up, do not press any key until switching is complete.
- You cannot use the simultaneous display until Windows starts up.
- Display switching by pressing «  » + «P»^{*3} or «Fn» + «F3» may not work when you use the Fast User Switching function to switch the user. In this case, log off all users and restart the computer.
- Do not connect or remove the external display during sleep^{*2} or hibernation.
- It may take some time to switch between displays depending on the displays used.
- When you use the external display only, set the suitable number of colors, resolution, or refresh rate separately from when you use the internal LCD only or when you use the simultaneous display.
Depending on the settings, some external displays may be distorted or may not display the mouse cursor correctly. In this case, set the settings to lower value.
- When you use the simultaneous display, DVD-Video, MPEG files and other motion image files may not be played back smoothly.
- Carefully read the instruction manual of the external display.
- When connecting an external display that does not conform to the Plug & Play standards, select the display driver accordingly in the following menu, or use the driver disc

supplied with the monitor.

Windows 7

1. Click  (Start) - [Control Panel] - [Adjust screen resolution] - [Advanced Settings] - [Monitor] - [Properties].
 - A standard user needs to enter an administrator password.
2. Click [Driver] - [Update Driver].

Windows XP

1. Click [start] - [Control Panel] - [Appearance and Themes] - [Display] - [Settings] - [Advanced] - [Monitor] - [Properties] - [Driver] - [Update Driver].

- If you connect an external display via the port replicator (For CF-53 Series: CF-VEB531/For CF-52 Series: CF-VEB522), the output switches to the port replicator from the external display port.

- <Only for CF-53 Series>

Until Windows startup is completed (during Setup Utility, etc.), the simultaneous display cannot be used and pressing «Fn» + «F3» switches the display between the internal LCD and the external display (the projector etc.).



- <Only for CF-53 Series>

When you use high resolution displays, the display color, resolution or refresh rate may be changed, switching to [Built-in Display] in [Intel® Graphics and Media Control Panel]. We recommend you to switch the output destination by pressing «» + «P»^{*3} or «Fn» + «F3».

Windows XP

- Simultaneous display and display switching do not work when [Command Prompt] screen is set to "Full Screen".
- If a picture is not displayed normally, lower the level of [Hardware acceleration] in the following menu.
[Start] - [Control Panel] - [Appearance and Themes] - [Display] - [Settings] - [Advanced] - [Troubleshoot]

CAUTION

- Before disconnecting the external display, switch to the internal LCD by pressing «» + «P»^{*3} or «Fn» + «F3». Otherwise the displayed image quality may become different after disconnection (e.g., wrong resolution). In this case, press «» + «P»^{*3} or «Fn» + «F3» to reset the image quality.
- The screen may become distorted due to the following operations. In this case, restart the computer.
 - Disconnecting an external display for which you have set high resolution or high refresh rate.

- Connecting/disconnecting an external display during computer operations.

*2 : Windows XP: standby

*3 : Windows 7 only

Display Selector <Only for CF-53 Series>

You can connect up to four external displays when using a port replicator.

When an external display is connected, you can use the simultaneous display function and the extended desktop function. The extended desktop function allows you to use the working area across both the internal LCD and the external display. You can drag an object around the displays.

The Display Selector utility allows you to easily activate/deactivate the simultaneous display function and the extended desktop function.

It also allows you to set the scaling rate of an external HDMI display.

1. Click  (Start) *4 - [All Programs] - [Panasonic] - [Display Selector].
2. Make the required settings.

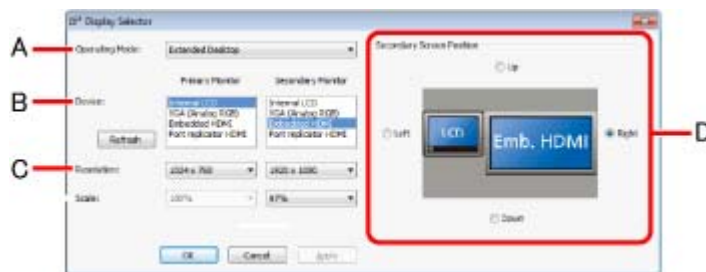

A: [Operating Mode]

Select [Single Display] to activate only one display.

Select [Extended Desktop] to activate the extended desktop function.

Select [Clone Displays] to activate two displays.

After making a selection, click [Apply]. The following settings can then be made.

B: [Device]

When [Extended Display] or [Clone Displays] is selected in [Operating Mode], select the displays to be used as the primary device and the secondary device.

When [Single Display] is selected, you can select only the primary device.

C: [Resolution]

Select the resolution of the display.

When [Extended Desktop] is selected in [Operating Mode], the resolution can be selected for

the primary device and the secondary device independently.

D: [Secondary Screen Position]

When [Extended Desktop] is selected in [Operating Mode], specify the position of the secondary monitor by selecting [Up], [Down], [Left] or [Right].

The display image with the black frame and the taskbar indicates the primary device, and the other indicates the secondary device.

3. Click [Apply] to enable the settings.
4. Click [OK].

*4 : Windows XP: [start]

NOTE

- It may not be possible to use the extended desktop with some software applications.
 - When using the extended desktop, if you click the maximize button, the window is displayed on one of the displays.
You cannot move the maximized window to the other display.
 - When both an analog display and an HDMI display are connected, and if you select [Extended Desktop] or [Clone Displays], three output destinations (internal LCD, external analog display, and external HDMI display) can be selectable at both primary device and secondary device. In this case, the external analog monitor is referred to as "PC monitor" and the HDMI display is referred to as "Digital Television".
 - <Only for model with touchscreen>
Set the internal LCD to the primary device when using the touchscreen. The cursor will move on the primary device when you touch the internal LCD.
-

Changing the Sound Output Destination

When an HDMI display is connected, you can specify sound to be output via the speakers of the personal computer or via the speakers of the HDMI display.

Make sure your HDMI display is equipped with speakers.

Windows 7

1. Click  (Start) - [Control Panel] - [Hardware and Sound] - [Sound] - [Playback].
2. Select the sound output destination.
3. Click [Set Default], and then click [OK].

Windows XP

1. Click [start] - [Control Panel] - [Sound, Speech, and Audio Devices] - [Audio].
2. Select the sound output destination in [Default Device].
3. Click [OK].

USB Devices

Connecting/Removing USB Devices

To connect the USB device

1. **Open the cover and connect the USB device to one of the USB ports (A),(B),(C) or (D) on the computer.**

For further information, refer to the instruction manual of the USB device.

<Only for CF-53 Series>

The USB port (B) supports USB3.0.

<CF-53 Series>

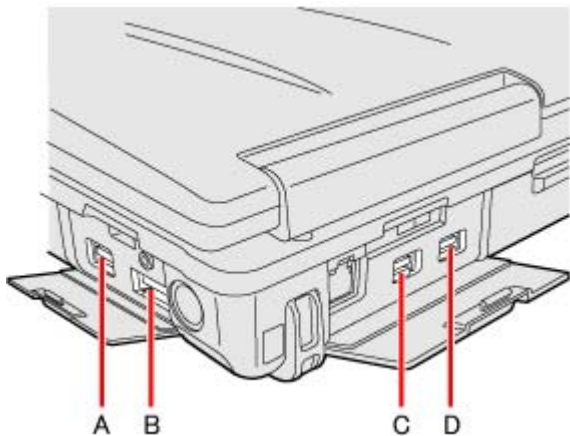

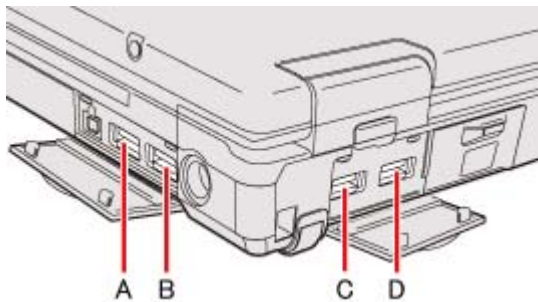

<CF-52 Series>





To remove the USB device

1. **Disable the USB device.**

Windows 7

1. Click  on the notification area and click .
2. Select the USB device.



Windows XP

1. Double-click  on the notification area.
 2. Select the USB device, then click [Stop].
 3. Follow the on-screen instructions.
- These steps are not necessary when;
 - Removing the device after turning off the computer.
 -  or  is not displayed.
 - The device does not appear in the list in step 2.



2. Remove the USB device.

CAUTION

<Only for model with Smart Card slot>

- If you double-click  or , [USB Smart Card Reader] is displayed in the list, but do not select this item. Removing this item is not possible. Restart the computer in case you select this.
-

NOTE

- You may need to install the driver for the USB device. Follow the on-screen instructions or refer to the instruction manual of the USB device.
- You may need to install the driver again when connecting the device to another port.
- When a USB device is connected, sleep^{*1} and hibernation may not function normally. If the computer does not start up normally, remove the USB device and restart the computer.
- When the USB device is removed and then inserted while the computer is on,  or  may appear in the Device Manager and the device may not be correctly recognized. In this case, remove and connect the device again, or restart the computer.
- When a USB device is connected, power consumption increases. Remove the USB device when it is not in use, especially when operating by battery power.

Windows 7

- If the computer enters sleep while a USB keyboard or mouse is connected, touching the USB keyboard keys or mouse will resume the computer.
-

*1 : Windows XP: standby

IEEE 1394 Devices

<Only for model with IEEE 1394 port>

You can connect a digital video camcorder or other IEEE 1394 standard device to the computer.

To connect IEEE 1394 device

1. Turn on the computer and the IEEE 1394 device.
2. Open the cover and connect the IEEE 1394 device to the IEEE 1394 interface connector (A).
 - For further information, refer to the instruction manual of the IEEE 1394 device.

<CF-53 Series>

 - If you connect this computer to a port replicator, remove (B)

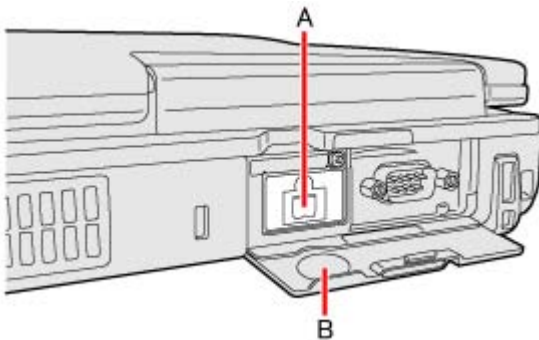

<CF-52 Series>

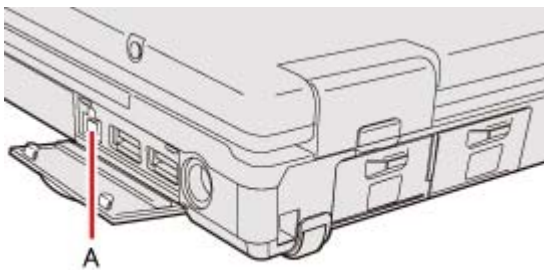

NOTE

- You may need to install the driver for the IEEE 1394 device. Follow the on-screen instructions or refer to the instruction manual of the IEEE 1394 device.
-

To remove IEEE 1394 device

CAUTION

- Turn off the IEEE 1394 device only after turning off the computer.

1. Turn off the computer and disconnect the cable from the IEEE 1394 interface connector.
2. Turn off the IEEE 1394 device and remove the cable.

Fingerprint Reader

<Only for model with Fingerprint Reader>

<CF-53 Series>



<CF-52 Series>



NOTE

- Enrollment and authentication is unavailable to an extremely minority of people including those whose fingerprints give little data for personal identification.
-

How to Use the Fingerprint Reader

This section explains how your fingerprints are enrolled and authenticated.

1. **Slide your finger toward yourself.**

- To prevent a reading error.
 1. Set the first joint of your index finger on the sensor as illustrated to the right.
 2. Slide your finger toward yourself while keeping it in contact with the fingerprint sensor (A).
 3. Slide your finger down until the sensor is visible.

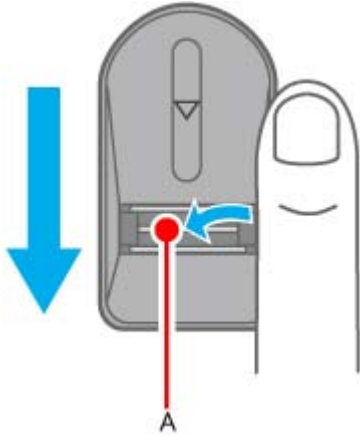

- When the fingerprint sensor does not enroll or authenticate your fingerprint properly:
 - You slid your finger too fast or too slow.
 - Your finger was soiled or it has a scar on the surface.
 - Your finger was wet or extremely dry.
 - Your fingerprint does not have sufficient data for personal identification.

For further information, refer to [Troubleshooting-Fingerprint Reader](#).

CAUTION

- We shall not be liable for any loss or damage whatsoever resulting from your Fingerprint device or neglect of Fingerprint device use, or any data loss resulting from such developments as Fingerprint authentication device malfunctioning.

Overview

Fingerprint's Outline

The conventional security systems use ID/passwords and token devices such as IC cards to authenticate users. Therefore the passwords and token devices are exposed to the risk of being lost, stolen and hacking.

The Fingerprint authentication method uses user's fingerprints instead of passwords for security authentication. You can use your fingerprints to start up your computer and log on Windows.

We recommend you use the Fingerprint Reader in combination with the TPM (Trusted Platform Module) to increase the security level of your computer.

Recommended Installation Procedure

(Performed by the Computer Administrator)

1. TPM Installation

(If the TPM is not being used, skip this step.)

2. Fingerprint Utility Installation

3. TPM Fingerprint Utility Initialization

(If the TPM is not being used, skip this step.)

(Performed by each user)

4. User Fingerprint Enrollment

User's Data

- Windows Logon Password
- Fingerprint
- Fingerprint Backup Password
- Power-on Security

To access the online manual

This manual describes step 2, 3 and the initial part of step 4.
For further steps, refer to the Protector Suite Help menu.

- Click  (Start)^{*1} - [All Programs] - [Protector Suite] - [Control Center] - [Help] - [Help].

*1 : Windows XP: [start]

Precautions

Security Functions

- **Fingerprint Authentication Technology does not guarantee complete authentication and individual identification. Please acknowledge we shall not be liable for any loss or**

damage whatsoever resulting from the use of, or inability to use your Fingerprint device.

- **The Fingerprint authentication method uses multiple fingerprints, encryption keys, credentials data and passwords. You might not be able to use your data if you lose fingerprints, keys, credentials and passwords. Back up the Fingerprint authentication data in a safe place. For further information, refer to [Backup](#).**
- **General interaction with third-party applications: There is no guarantee that there will not be any negative interaction with any third-party software, and will not accept any responsibility for such an interaction.**

Installation

1. TPM Installation

Refer to the *Installation Manual* of "Trusted Platform Module (TPM)".

○ **Windows 7**

Click  (Start), input "c:\util\drivers\tpm\readme.pdf" in [Search programs and files], and press «Enter».

○ **Windows XP**

Click [start] - [Run] and input "c:\util\drivers\tpm\readme.pdf", and click [OK].

2. Fingerprint Utility Installation

Performed by the Computer Administrator.

1. Log on to Windows as an Administrator.
2. Close all other programs.

■ **Windows 7**

(For 32bit OS)

Click  (Start), input "c:\util\drivers\fngprint\install\32-bit\Setup.exe" in [Search programs and files], and press «Enter».

(For 64bit OS)

Click  (Start), input "c:\util\drivers\fngprint\install\64-bit\Setup.exe" in [Search programs and files], and press «Enter».

■ **Windows XP**

Click [start] - [Run] and input "c:\util\drivers\fngprint\install\32-bit\Setup.exe", and click [OK].

3. Click [Next].

Installation starts. Follow the on-screen instructions.

4. When the "Protector Suite *.* has been successfully installed." message appears, click [Finish].

At the confirmation message, click [Yes].

The computer restarts.

5. Log on to Windows as an Administrator.

The "Fingerprint software Icon"  appears in the notification area.

- If the icon does not appear, click .

3. TPM Fingerprint Utility Initialization

Performed by the Computer Administrator.

The "Invalid TPM status" message is displayed by the "Fingerprint software Icon"  in the notification area.

- If the icon does not appear, click .



- If the TPM is not being used, skip this step.

1. Click on the "Invalid TPM status" message and then click [Initialize].

Follow the on-screen instructions.

NOTE

- If the "Invalid TPM status" message is not displayed

1. Click  (Start)^{*2} - [All Programs] - [Protector Suite] - [Control Center] - [Settings] - [Advanced Settings] - [Trusted Platform Module (TPM)] - [Initialize]. And then click  (Start)^{*2} - [All Programs] - [Protector Suite] - [Control Center] - [Identity] - [Multifactor], and choose a method of authentication.
-

4. User Fingerprint Enrollment

Performed by each user.

1. Double-click the "Fingerprint software Icon" .
2. Carefully read the License Agreement, and then click [Accept].
3. Select an enrollment mode, and click [Apply].

- Enrollment mode

You can make the configuration for the enrollment only once during this initialization phase.

- Enrollment to the biometric device

All enrolled fingerprints are stored directly in the fingerprint sensor. The user data will be secured by the hardware protection keys obtained by the

fingerprint sensor. This mode allows up to about 21 fingerprints to be enrolled.

- Enrollment to the hard disk

All enrolled fingerprints are stored on the hard disk. Hardware protection of the user data is not possible, but multiple users can enroll their fingerprints.

- Follow the on-screen instructions.

NOTE

- Enroll at least two fingers. Even if one of them is injured, you can use another one to access your account and secret data. For further information about the enrollment, refer to [How to Use the Fingerprint Reader and \[Tutorial\]](#).

1. Click  (Start)^{*2} - [All Programs] - [Protector Suite] - [Control Center] - [Help] - [Tutorial].
-

- We recommend you use the Power-on Security feature. This feature prevents unauthorized access to the user's computer at the BIOS level.

1. Click  (Start)^{*2} - [All Programs] - [Protector Suite] - [Control Center].
2. Click [Identity] - [Status].
3. Click [Power-on security status] - [Change].
4. Click [Edit], and Add the check mark to [Enable power-on security], and then click [Apply].
5. Click [Identity] - [Power-on Password].
6. When the "Power-on Security" screen appears, click [Manage Passwords...].
7. Select [Power-On] in [Password Types], and click [Set password...].
8. Enter the Power-On password, and click [OK].
9. Click [Close].
10. Add a check mark for [Power-On] in [Password Types].
11. Enter the Power-On password, and click [OK].
12. Click [Apply].

*2 : Windows XP: [start]

More Advanced Security

You can increase your computer's security level by setting the BIOS level described in this section. Performed by the Computer Administrator.

1. Register the Supervisor Password.

You have to register the Supervisor Password to proceed to the next step.

If you have already registered the Supervisor Password, you can skip this step, and move on to step 2.

If you have not done this, have enrolled your fingerprint using Protector Suite, and have already made Power-on Security effective, after step 2, your fingerprint authentication will be necessary.

1. Turn on or restart the computer.
2. Press «F2» or «Del» while [Panasonic] boot screen is displayed soon after the computer starts the startup procedure.
3. Select the [Security] menu.
4. Select [Set Supervisor Password], and press «Enter».
5. Enter your password in the [Create New Password], and press «Enter».
 - The password will not be displayed on the screen.
 - You can use up to 32 alphanumeric characters (including spaces).
 - The case (upper/lower) is distinguished.
 - Use only the upper horizontal row of numeric keys to input your password.
 - You cannot use «Ctrl» to input a password.
6. Enter your password again in [Confirm New Password], and press «Enter».

2. Set the High Security Level.

1. Select [Fingerprint Security], and press «Enter».
2. Select [Security mode], and select [High].
 - Default setting: Simple
3. Press «Esc» to close the sub-menu.
4. Press «F10», select [Yes], and press «Enter» to exit the Setup Utility.

NOTE

- In the [High] security mode, you have to enter the Supervisor or User Password even after fingerprint authentication.

In the [Simple] security mode, you do not have to enter the Supervisor or User password after fingerprint authentication.

- To use the Power-on Security feature, enable it in [\[Control Center\]](#).

Do not use the fingerprint lists in the Setup Utility to change the setting for [Power-on Security] except for the specific case such as the fingerprint reader cannot be used.

Useful Information

Backup

The file described below is necessary for recovering the Fingerprint authentication data. Back up

this file periodically in a safe location such as removable disk to avoid data loss resulting from some accidents. We recommend you to store the file in a removable disk or network drive because the benefit of Fingerprint authentication security can be reduced if you keep the file in the internal hard disk drive.

The backup password described below is necessary for bypassing the Fingerprint authentication. We recommend you set the backup password using the [User Enrollment] wizard. If you do not define the backup password, you may lose your data in case of authentication hardware failure.

- **File used by each user**

- Backup user passport data
(Default name: <UserAccount>.vtp)

You need this file when you replace the embedded fingerprint chip, or the hard disk drive, or when reinstalling Windows. This file contains the fingerprints, encryption keys, and logon authentication data.

NOTE

- How to Backup:

Select [Identity] in [Account Operation] to save the user data.

1. Click  (Start)^{*3} - [All Programs] - [Protector Suite] - [Control Center] - [Identity] - [Account Operation].

For further information, refer to the Protector Suite Help menu.

1. Click  (Start)^{*3} - [All Programs] - [Protector Suite] - [Control Center] - [Help] - [Help].
-

- **Password used by each user**

- Backup Password for Enrollment

This backup password can be used in case of hardware failure to bypass the fingerprint authentication.

CAUTION

- The passwords other than those explained above are also used for security, so do not lose them.

For further information, refer to the Protector Suite Help menu.

1. Click  (Start)^{*3} - [All Programs] - [Protector Suite] - [Control Center] - [Help] - [Help].
-

*3 : Windows XP: [start]

Limitations in Use

- **Password Bank^{*4} limitations: The following web pages cannot be supported. Web pages which are created by the following technologies:**
 - Web forms created on the fly using javascript.
 - Web forms which looks as one form (e.g. login field, password field), but internally created with two independent forms.
 - There can be auto submit problems with web forms which do not have Submit button. All forms that you cannot submit with «Enter» will be entered by Password Bank, but not submitted.
- **Password Bank^{*4} limitations: The following Windows applications cannot be supported.**
 - Applications which do not use standard Windows controls and draw controls by their own.
 - This includes any Java based application.
- **"Sensor Scrolling Feature" is not supported.**

*4 : For further information, refer to the Protector Suite Help menu.

- Click  (Start)^{*5} - [All Programs] - [Protector Suite] - [Control Center] - [Help] - [Help].

*5 : Windows XP: [start]

Handling & Maintenance

- **The enrolling and authentication sensitivity may decline under the conditions below. Wipe off stains or moisture on the sensor surface with a soft cloth.**
 - The surface of the fingerprint sensor is soiled with dust, skin oil, or sweat.
 - The surface of the fingerprint sensor is wet as a result of moisture or condensation.
- **Static electricity may also cause the sensor to malfunction. To make your finger static-free, touch a metal surface before placing it on the fingerprint sensor. Exercise caution against static electricity in winter and other dry conditions.**
- **Malfunction or damage may occur when:**
 - The fingerprint sensor surface was damaged by the strong rubbing of a solid material, scratches, or being pecked with a pointed item.
 - The sensor was touched with a finger soiled with mud, damaging the sensor surface with a tiny substance, and staining the surface.
 - The sensor surface was covered with a seal, or soiled with ink.

Deleting (Initializing) Owner's Data

When you dispose of the computer or transfer the ownership, delete (initialize) the owner's data to avoid unauthorized access.

NOTE

- The data enrolled in the fingerprint sensor is not image data. You cannot restore fingerprint image data from the data enrolled in the fingerprint sensor.

1. Disable Power-on Security

1. Log on to Windows as an Administrator.
2. Click  (Start)^{*6} - [All Programs] - [Protector Suite] - [Control Center].
3. Click [Identity] - [Status] - [Power-on security status].
4. Click [Edit], and remove the check mark from [Enable power-on security], and click [Apply].
5. Click [Identity] - [Power-on Password].
6. Click [Manage Passwords...].
7. Select [Power-On] in [Password Types], and click [Unset password...].
8. Enter the Power-On password, and click [OK].
9. Click [Close].
 - Confirm that fingerprint data is not registered.

2. Delete Fingerprint Data.

Performed by each user.

1. Click  (Start)^{*6} - [All Programs] - [Protector Suite] - [Control Center].
2. Click [Identity] - [Account Operation].
3. Click [Delete user data].
 - At the confirmation message, click [Yes].
4. Enter Windows log on password then, click [Submit].
 - Confirm that there is no item in [Password Types].

3. Uninstall Protector Suite

Performed by the Computer Administrator.

1. Log on to Windows as an Administrator.
2. Close all programs.
3. Click  (Start)^{*6} - [Control Panel] - [Uninstall a program].
4. Double-click [Protector Suite *.*], and select [Remove].
5. Select [Remove all Protector Suite *.* data], and click [Next].
 - Uninstallation starts. Follow the on-screen instructions.

6. When the "Protector Suite *.* has been successfully uninstalled." Message appears, click [Finish].
 - If the confirmation message appears, click [Yes].
 - The computer restarts.

*6 : Windows XP: [start]

Starting Over

If the specific solutions for your problem in [Troubleshooting-Fingerprint Reader](#) do not work, you can use these instructions as the last measure and start over. However, please note that you can lose your data - passwords, secret keys and fingerprints.

1. Log on to Windows as an Administrator.

- You can always access the computer by using your Windows log on password.

2. Try to export your passport to a file if you are planning to use your passwords, secret keys or enrolled fingers in the future.

- If you exported your passport recently, this step is not required.
- If biometrics authorization works and your finger is recognized, use [Account Operation] wizard, swipe your finger and continue according to wizard's instructions.
- If biometrics authorization works, but your finger is not recognized, you can start the [Account Operation] wizard and export the passport even without using your fingerprint. You need to cancel fingerprint dialog, and you will be prompted for a password. If you do not use backup password, enter your Windows log on password. Otherwise, enter your backup password.

CAUTION

- We recommend you set the backup password.

- If biometrics authorization does not work, there is no way to backup your data.
-

3. Deleting the passport.

- Use the [Delete your data] wizard. Please note that all your stored secret data (passwords, [File Safe] encryption keys [Personal Safe] data) will be lost. If you backed up the data, you can restore it in the next step; otherwise it will be lost permanently. To perform the delete operation it is necessary to cancel the fingerprint verification operation to get to the password dialog, then enter your Windows log on password or backup password.

4. Make sure your fingerprint sensor is working.

- Use the Tutorial wizard to verify that the fingerprint sensor works. If not, reboot and try

again. If it still does not work, please contact Panasonic Technical Support.

5. Restore or create passport.

- If you have a backup of your data, you can now use [Account Operation] wizard to restore your data. Otherwise you can create a new passport by using the [Manage Fingerprints] wizard.

Modem

<Only for model with Modem>

Connecting the Internal Modem with a Telephone Jack

CAUTION

- Use a surge protector since the modem may be damaged by a sudden high voltage surge that may occur in the event of a lightning strike.

1. Open the cover (A), and connect the computer and the telephone jack (B) using the telephone cable (C).

- Hold the cable so that the shape of the connector (D) matches the port, and insert fully until it clicks.

<CF-53 Series>

- If you connect this computer to a port replicator, remove (E)

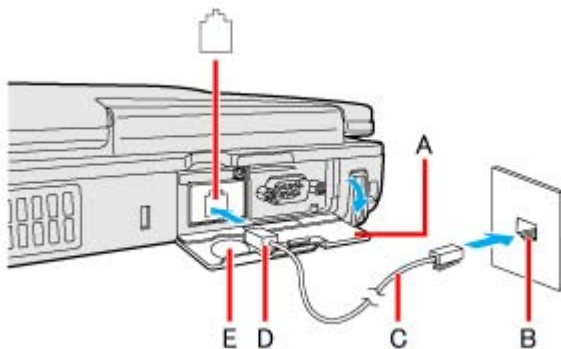

<CF-52 Series>

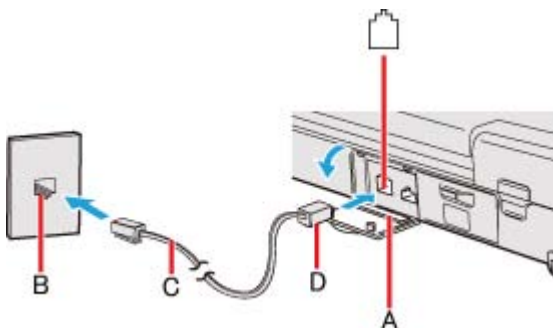

2. Windows 7

Click  (Start) - [Control Panel] - [Connect to the Internet] - [Dial-up].

Windows XP

Click [start] - [Control Panel] - [Printers and Other Hardware] - [Phone and Modem Options].

3. Change the settings as necessary.**NOTE**

- Do not enter sleep^{*1} or hibernation during communications.
 - To remove the cable, press and hold the lever and pull out.
-

*1 : Windows XP: standby



Ring Resume Function

The computer automatically resumes from sleep^{*2} when the telephone connected to the modem rings.

You will need software to keep the computer in idle state waiting for a phone call, and if you prefer, to turn the computer to sleep^{*2} again afterward. For further information, refer to the instruction manual of the software application.

To enable this function

Windows 7

1. Click  (Start) - [All Programs] - [Windows Fax and Scan].
2. Click [Tools] - [Fax Settings].
 - A standard user needs to enter an administrator password.
 - Check whether the modem you are using is displayed in Device name. If not, click [Select fax device] and select the correct modem.
3. Add a check mark for [Allow the device to receive fax calls] and click [OK].
4. Click  (Start) - [Computer] - [System properties] - [Device Manager].
 - A standard user needs to enter an administrator password.

5. Double-click [Modems], and then double-click the internal modem.
6. Click [Power Management] and add a check mark for [Allow this device to wake the computer], and then click [OK].



Windows XP

1. Click [start] - [Control Panel] - [Performance and Maintenance] - [System] - [Hardware] - [Device Manager].
2. Double-click [Modems], and then double-click the internal modem.
3. Click [Power Management], add the check mark for [Allow this device to bring the computer out of standby], and click [OK].

To set the time to return the computer to sleep^{*2}

The computer will enter sleep^{*2} after the set time even when the communication is not completed. You can avoid such uncompleted communication if you select [Never], but the computer does not return to sleep^{*2} after resuming by a phone call.

1. Windows 7

Click  or  on the notification area and click [More power options] - [Change when the computer sleeps].

Windows XP

Click [start] - [Control Panel] - [Performance and Maintenance] - [Power Options] - [Power Schemes].

2. Set the expected communication time for the sleep^{*2} setting.

NOTE

- This function does not work when the computer is off or in hibernation.
- Connect the AC adaptor.
- The screen remains dark after the computer resumes from sleep^{*2}. The previous screen display will be restored when you touch the keyboard, touch pad, touchscreen (only for model with touchscreen).
- The computer cannot resume if the telephone is not connected to the internal modem. (e.g., you cannot use a PC Card modem.)
- The computer needs some time to respond, so set the calling time longer than normal. If this is not possible on the transmission side, reduce the number of rings before

answering on the software that you are using to keep the computer in idle waiting for the call.

*2 : Windows XP: standby

LAN

Connecting LAN

CAUTION

- Do not connect the telephone cable to the LAN port.

1. Turn off the computer.

- Do not use sleep^{*1} or hibernation.

2. Open the cover and connect the cable.

- Connect the LAN port (A) and the network system (server, HUB, etc.) using a LAN cable.

<CF-53 Series>

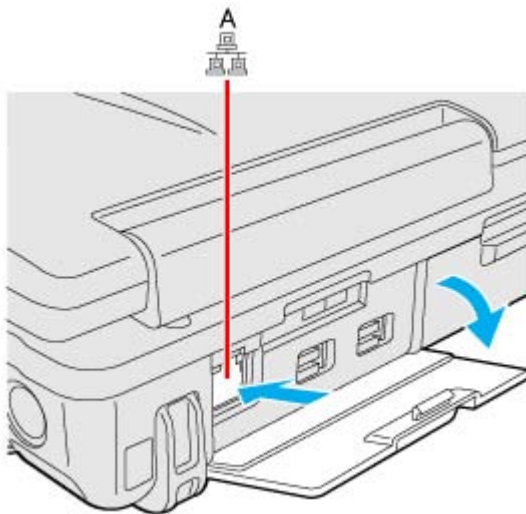

<only for model with 2nd LAN>

- If you connect this computer to a port replicator, remove (B)

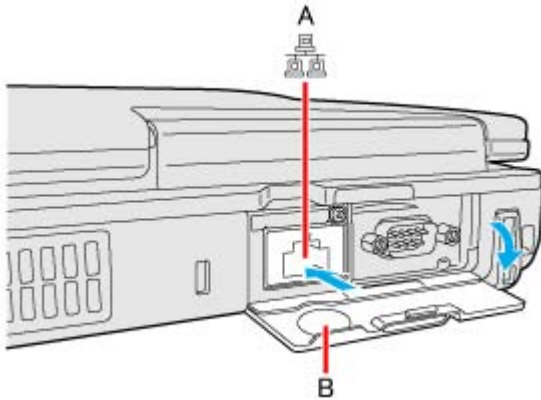

<CF-52 Series>

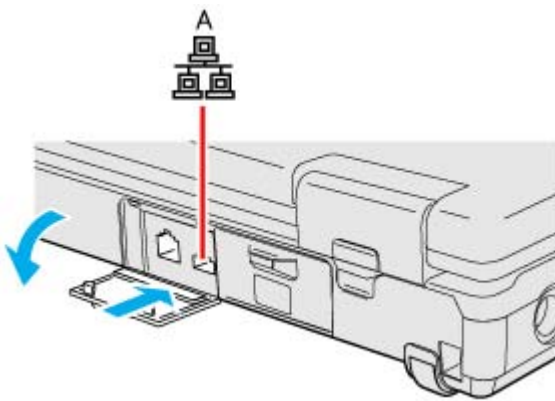

3. Turn on the computer.

To check the Local Area Connection status

Windows 7

1. Click  (Start) - [Control Panel] - [View network status and tasks].

Windows XP

1. Click [start] - [Connect To] - [Show all connections].

NOTE

<only for model with 2nd LAN>

- The communication speed using the 2nd LAN port is lower than that of the other LAN port.
-

Power On by LAN/Wake Up from wired LAN

NOTE

- **When these functions are enabled, power is consumed even if the computer is in sleep^{*1}, hibernation, or powered off. Be sure to use the AC adaptor.**
 - Even when a password is set in the Setup Utility and [Password On Boot] is set to [Enabled], entering the password is unnecessary for turning on or resuming the computer.
 - The Power On by LAN function is off under the following conditions:
 - When you turn the computer off by pressing the power switch for 4 seconds or longer (e.g., after a hung-up).
 - When you reattach the AC adaptor and battery pack to the computer after removing them.
 - The screen remains dark when the computer resumes from sleep^{*1}. The previous screen display will be restored when you touch the keyboard, touch pad, touchscreen (only for model with touchscreen).
-

*1 : Windows XP: standby

Enabling the Power On by LAN function

The computer automatically turns from off to on when the computer is accessed from the network server via the internal LAN port.

1. Select [Allow] in [Power On by LAN] in the [Advanced] menu of the Setup Utility.
2. In [Caution], press «Enter».
3. Press «F10», and then select [Yes] and press «Enter».
4. Log on to Windows as an administrator.

5. **Windows 7**

Click  (Start) - [Computer] - [System properties] - [Device Manager].

Windows XP

Click [start] - [Control Panel] - [Performance and Maintenance] - [System] - [Hardware] - [Device Manager].

6. Double-click [Network adapters] - [Intel(R) 82579LM Gigabit Network Connection], and then click [Advanced].
7. Click [Enable PME] in [Property] and select [Enabled] in [Value], and then click [OK].

NOTE

- The computer may accidentally turn on if the linkage status is changed. To prevent the accidental startup, make the setting by the following steps.

1. **Windows 7**

Click  (Start) - [Computer] - [System properties] - [Device Manager].

- o A standard user needs to enter an administrator password.

Windows XP

Click [start] - [Control Panel] - [Performance and Maintenance] - [System] - [Hardware] - [Device Manager] - [Network adapters].

2. Double-click [Network adapters] - [Intel(R) 82579LM Gigabit Network Connection], and click [Advanced].

3. **Windows 7**

Click [Wake on Magic Packet] in [Property] and select [Enabled] in [Value], and then click [OK].

Windows XP

Click [Wake on Settings] in [Property] and select [Wake on Magic Packet] in [Value], and click [OK].

- If you forcibly shut down Windows, the Power On by LAN function will not work.

<Only for the model with 2nd LAN>

- The 2nd LAN port does not support the Power On by LAN function.

Enabling/Disabling the Wake Up from wired LAN function

When the Wake Up from wired LAN function is enabled, the computer automatically resumes from sleep^{*2} or hibernation when the computer is accessed from the network server via the internal LAN port. (Default setting)

The Wake Up from wired LAN function can be switched to enable/disable by performing the following procedure.

1. **Windows 7**

Click  (Start) - [Computer] - [System properties] - [Device Manager].

- A standard user needs to enter an administrator password.

Windows XP

Click [start] - [Control Panel] - [Performance and Maintenance] - [System] - [Hardware] - [Device Manager].

2. Double-click [Network adapters] - [Intel(R) 82579LM Gigabit Network Connection], and click [Power Management].
3. Select the setting for [Allow the computer to turn off this device to save power] and [Allow this device to wake the computer]^{*3}, and click [OK].
 - We recommend you to make the above 2 settings ON/OFF simultaneously.

NOTE

- The computer may start up if accessed by another computer on the network. The following procedure can be used to prevent startup due to unintentional access by a computer.

1. **Windows 7**

Click  (Start) - [Computer] - [System properties] - [Device Manager].

- A standard user needs to enter an administrator password.

Windows XP

Click [start] - [Control Panel] - [Performance and Maintenance] - [System] - [Hardware] - [Device Manager].

2. Double-click [Network adapters], and double-click the internal network adaptor.
 3. Click [Power Management], add a check mark for [Only allow a magic packet to wake the computer]^{*4}, and then click [OK].
-

*2 : Windows XP: standby

*3 : Windows XP: [Allow this device to bring the computer out of standby]

*4 : Windows XP: [Only allow management stations to bring the computer out of standby]

Disabling/Enabling Wireless Communication

<Only for model with wireless LAN, Bluetooth, and/or wireless WAN>

There are several ways of disabling and enabling wireless communication.

- The wireless switch on the front of the computer (below)
- [Wireless switch utility](#)
- Settings [[Wireless Switch](#)] in the [Advanced] menu of the Setup Utility
- Setting in the [Wireless Connection Disable Utility](#)

Windows 7

- Settings in the Network and Sharing Center (➔ [Using the Wireless LAN Function](#))

NOTE

- For further information about [Wireless LAN](#).
 - For further information about [Bluetooth](#).
 - For further information about Wireless WAN: (➔ [Wireless WAN](#))
 - The wireless communication can be enabled or disabled by connecting or disconnecting the LAN cable. (➔ [Wireless Connection Disable Utility](#))
-
-

The Wireless Switch

To disable all wireless communication

1. Switch to OFF.

To enable wireless communication

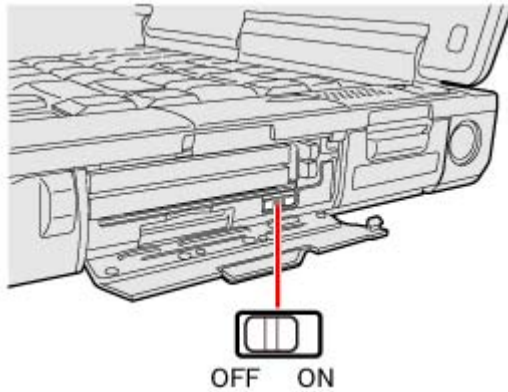

1. Switch to ON.
 - In the default setting, the wireless switch enables all wireless devices when it is set to ON.
- <CF-53 Series>

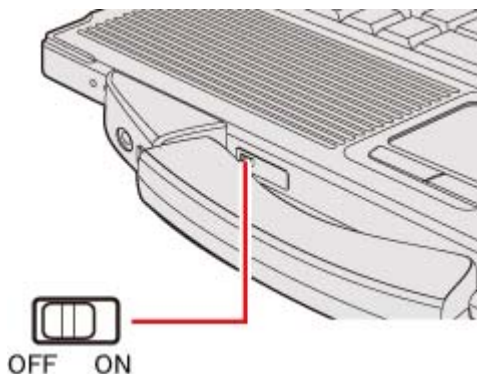

<CF-52 Series>







To check the wireless communication status

1. Click  on the notification area and place the cursor over the Wireless Switch Utility icon ( or ).

A tooltip appears.

NOTE









- The Wireless Switch Utility icons ( and ) indicate the on/off status of wireless communication, not the IEEE802.11a setting.
- If the setting is changed in [Device Manager], the display will be changed accordingly.
- If you uninstall the Wireless Switch Utility, set the wireless switch to ON beforehand.
- Do not turn on/off the switch repeatedly at too short intervals.
- Do not restart, log off, or enter sleep^{*1} or hibernation immediately after turning on/off the switch.
- Do not turn on/off the switch while Windows is starting up.

- To use wireless communication, set the wireless devices ([Wireless LAN] / [Bluetooth] / [Wireless WAN]) to [Enabled] (default) in the [Advanced] menu of the Setup Utility ( [Wireless Configuration](#)).
- When you set [\[Wireless Switch\]](#) to [Disabled] in the [Advanced] menu of the Setup Utility, the Wireless Switch Utility icon will not appear if you click  on the notification area. All wireless equipment (wireless LAN, Bluetooth, wireless WAN) will remain ready irrespective of the wireless switch setting.
- It may take some time to turn off wireless communication after switching the wireless switch off.
- If the setting is changed in [\[Device Manager\]](#), the display will be changed accordingly.

Windows 7

- You can check the wireless LAN communication status in Intel[®] PROSet/Wireless Software. Perform the following procedure.
 - Click  (Start) - [All Programs] - [Intel PROSet Wireless] - [WiFi Advanced Statistics].

Windows XP

- <Only for model with Intel[®] Centrino[®] Advanced N-6205>
Perform either of the following procedures to check the status in Intel[®] PROSet/Wireless Software.
 - Double-click ,  or  on the notification area.
 - Click [start] - [All Programs] - [Intel PROSet Wireless] - [WiFi Connection Utility].
- <Only for model with Atheros AR928X>
 - Right-click , , , , or  on the notification area, and click [Open Atheros Client Utility].
 - Click [start] - [All Programs] - [Atheros] - [Atheros Client Utility].



*1 : Windows XP: standby

Wireless Switch Utility

This utility allows you to control the function of the wireless switch. This utility also allows you to enable or disable wireless devices from a pop-up menu. In the default setting, all wireless devices are enabled.

The Wireless Switch Utility icon

The icon appears when click  on the notification area. It shows the status of wireless devices.

-  : Indicates that the wireless devices are enabled.
-  : Indicates that the wireless devices are off.
-  : Indicates that the wireless devices have been disabled in the Setup Utility.

To enable or disable particular wireless devices

1. Click the Wireless Switch Utility icon to show the pop-up menu.
2. Select ON or OFF for the device you want to enable or disable.

To change the function of the wireless switch

In the default setting, the wireless switch enables devices that you select turning the wireless switch off last time. You can change this function.

- **[Selects the device for which to turn the device status on each time with the dialog box.]**



Display a dialog each time you set the wireless switch to ON so you can choose which wireless device to enable.

- **[Turns on the following device.]**

Only selected devices are enabled when you set the wireless switch to ON.

- **[Turns on the device that was on immediately before the wireless switch was turned off the last time.] (default)**

When you turn on the wireless switch, the on/off settings that were selected when you last turned off the wireless switch will be restored.

1. Click  on the notification area and click the Wireless Switch Utility icon ( or ).
2. Click [Settings].
3. Select the setting you want to assign to the wireless switch.
4. Click [OK].

Wireless Connection Disable Utility

You can automatically disable the wireless LAN/wireless WAN connection when a LAN cable is connected to your computer. You need to install the Wireless Connection Disable Utility to use this function.

Installing the utility

1. Log on to Windows as an administrator.

2. **Windows 7**

Click  (Start), input "c:\util\wdisable\setup.exe" in [Search programs and files], and press «Enter».

Windows XP

Click [start] - [Run] and input "c:\util\wdisable\setup.exe", and click [OK].

3. Follow the on-screen instructions to install the Wireless Connection Disable Utility.

Checking the status of the wireless connection

NOTE

- The Wireless Switch Utility should also be installed so that the Wireless Connection Disable Utility works. The Wireless Switch Utility has already been installed at the factory.
 - To use the utility, set [Wireless Switch] to [Enabled] in the [Advanced] menu of the Setup Utility.
 - The utility does not automatically disable the Bluetooth connection.
-

Status indication

After installation, the Wireless Connection Disable Utility is automatically started after a user is logged in. An icon appears when click  on the notification area.



: Indicates that

- the utility is enabled, and
- the wireless connection is disabled since a LAN cable is connected.



: Indicates that

- the utility is enabled, and
- the wireless connection is enabled since no LAN cable is connected.

 : Indicates one of the following statuses;

- the utility does not monitor the LAN port status,
- the Wireless Switch Utility has not been started, or
- LAN is disabled in the [Advanced] menu of the Setup Utility or in the device manager.

Menu

Right-clicking the utility icon opens a menu as follows.

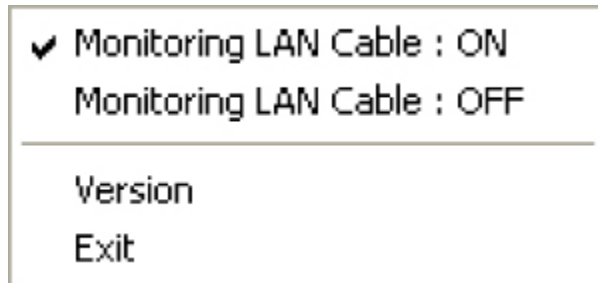

Clicking the menu item causes the following utility action.

- **Monitoring LAN Cable: ON**

Enables the Wireless Connection Disable Utility to monitor the LAN port and disable wireless connection when a LAN cable is connected.

- **Monitoring LAN Cable: OFF**

Disables the Wireless Connection Disable Utility, and enables wireless connection regardless of whether a LAN cable is connected or not.

- **Exit**

Exits the Wireless Connection Disable Utility and enables wireless connection.

Wireless LAN

<Only for model with wireless LAN>

CAUTION

- Do not use wireless LAN on airplanes, in hospitals, or in other locations where wireless LAN signals may affect devices.

Follow the instructions of airline companies and hospitals. If you use the computer in these locations, turn off the wireless LAN.

- To avoid unauthorized access to the computer through wireless LAN

We recommend you to make security settings such as encryption before using wireless LAN. Otherwise the hard disk data such as the shared files can be exposed to the risk of unauthorized access.

NOTE

- Communication is established through the wireless LAN antenna (A). Do not block the antenna area with your hand or body.

<CF-53 Series>

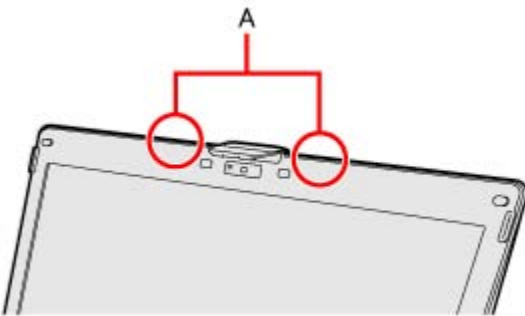

<CF-52 Series>

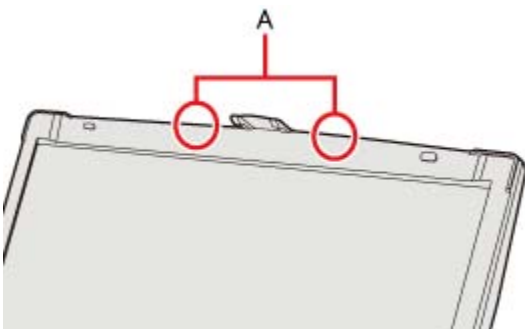

- When you connect this computer to a port replicator compatible with external antenna, you can switch the internal antenna to the external antenna, or vice versa.
(➡ [Wireless Antenna Switching](#))
 - You cannot use the wireless LAN function together with the Fast User Switching function.
 - The transmission rate will be lower when a microwave oven is used near by.
 - To use wireless LAN, set [[Wireless LAN](#)] to [Enabled] (default) in the [Advanced] menu of the Setup Utility.
 - It may take some time to turn off wireless LAN after switching the wireless switch to off.
-
-



Using the Wireless LAN Function

Before using a wireless LAN, turn the wireless LAN communication on.

Turning on/off the wireless LAN communication

1. Slide the wireless switch to turn ON / OFF wireless LAN (➡ [The Wireless Switch](#)).

Windows 7

- o When turning on wireless LAN
If you cannot turn on wireless LAN using the wireless switch, confirm the [Wireless Switch Utility](#) setting, If you cannot turn on wireless LAN in the Wireless Switch Utility, try the following procedure.
 1. Click  or  on the notification area and click [Open Network and Sharing Center].
 2. Click [Change adapter settings].
 3. Right-click [Wireless Network Connection] and click [Enable].
 - A standard user needs to enter an administrator password.
 - When [Disable] is displayed, [Wireless Network Connection] is already enabled.
 4. Turn on wireless LAN in the [Wireless Switch Utility](#).



NOTE

- You can use the following procedure instead of turning on wireless LAN in the Wireless Switch Utility.
 1. Click  (Start) - [Control Panel] - [Adjust commonly used mobility settings].
 2. Click [Turn wireless on] in [Wireless Network].
 - When [Turn wireless off] is displayed, the wireless network is already on.
 - If you cannot select [Turn wireless on], the wireless switch is turned off.
-
-

Setting the wireless LAN access point **Windows 7**

Preparation

Follow the instruction manual of the wireless LAN access point to make settings for the access point to recognize the computer.

1. Turn the wireless LAN on.
2. Click  or  on the notification area.
3. Select an access point, and click [Connect].
4. Input the key you set for the access point to recognize the computer, and click [OK].



Wait for the computer to connect to the wireless LAN access point.

When the icon on the notification area is changed to , the wireless LAN setting is complete.

5. Click [Close].

NOTE

- The settings depend on the network environment. For further information, ask the system administrator or the person in charge of the network.
- If you use the stealth type wireless LAN access point which restricts automatic detection of the wireless LAN access point, take the following procedure.
If you do not perform the procedure below, you may not be able to access the wireless LAN access point automatically or the wireless LAN access point may not be displayed on the [Connect to a network] screen.



1. Click , , or  on the notification area, click [Open Network and Sharing Center] - [Set up a connection or network] - [Manually connect to a wireless network] and click [Next].
 2. Input necessary information and add check marks for [Start this connection automatically] and [Connect even if the network is not broadcasting] and click [Next].
-

Setting the profiles **Windows XP**











<For model with Intel® Centrino® Advanced N-6205>

1. Double-click  /  /  on the notification area.

The [Intel® PROSet/Wireless WiFi Connection Utility] screen appears.

- When  or  is displayed, skip step 2.
- 2. When you double-clicked  in step 1, slide the wireless switch to turn on.
- 3. Click [Profiles] and click [Add].
- 4. Enter the profile name and WiFi Network Name (SSID), and make other necessary changes, then click [Next].
- 5. Make necessary settings and click [OK].
- 6. Select the profile you set and click [Connect].
- 7. Click [Close].

<For model with Atheros AR928X>

- 1. Right-click  /  /  /  /  on the notification area, and click [Open Atheros Client Utility].
The [Atheros Client Utility] screen appears.
 - When , ,  or  is displayed, skip step 2.
- 2. When you right-clicked  in step 1, slide the wireless switch to turn on.
- 3. Click [Profile Management], and click [New].
- 4. Enter the profile name and wireless network name (SSID), and make other necessary changes, then click [OK].
- 5. Select the profile you set and click [Activate].
- 6. Click .



NOTE

- You need to set the profile for each user.
- The settings depend on the network environment. For further information, ask the system administrator or the person in charge of the network.
- <Only for model with Intel[®] Centrino[®] Advanced N-6205>
For further information of Intel[®] PROSet/Wireless software, refer to [Help] in the menu bar.
- <Only for model Atheros AR928X>



For further information of Atheros, click [Help] - [Atheros Client Utility Help] in the menu bar.

<Only for model with Intel® Centrino® Advanced N-6205>

Enabling/Disabling the Wireless LAN Standard IEEE802.11a (802.11a)

1. Click  on the notification area and click  or .
2. Click [802.11a Enabled] or [802.11a Disabled].

NOTE

- In some countries, communication using IEEE802.11a (5 GHz wireless LAN) standard is restricted by law.
- The Wireless Switch Utility icon ( or ) indicates the on/off status of wireless LAN and/or Bluetooth and/or wireless WAN, not the setting of IEEE802.11a.
- If IEEE802.11a is enabled or disabled while the computer is connected to an IEEE802.11b/g access point, the connection will be temporarily interrupted.
- You can also change the IEEE802.11a setting in [Device Manager].

1. **Windows 7**

Click  (Start) - [Computer] - [System properties] - [Device Manager].

- o A standard user needs to enter an administrator password.

Windows XP

Click [start] - [Control Panel] - [Performance and Maintenance] - [System] - [Hardware] - [Device Manager].

2. Double-click [Network adapters] and double-click [Centrino(R) Advanced-N 6205 AGN].
3. Click [Advanced], and then select [Wireless Mode] in [Property].
4. Select the settings in [Value].
5. Click [OK].

If you enable or disable 802.11a using the pop-up menu of Wireless Switch Utility, the setting in [Device Manager] will be accordingly changed as below.

Settings in Device Manager		Settings in Wireless Switch Utility	
Windows 7	Windows XP	When 802.11a is enabled	When 802.11a is disabled

[6. 802.11a/b/g] [4. 802.11b/g]	[802.11a, 802.11b and 802.11g] [802.11b and 802.11g]	a+b+g+n is enabled	b+g+n is enabled
[3. 802.11g] [5. 802.11a/g]	[802.11g only] [802.11a and 802.11g]	a+g+n is enabled	g+n is enabled
[1. 802.11a] [2. 802.11b]	[802.11a only] [802.11b only]	a+n is enabled	b is enabled

Bluetooth

<Only for model with Bluetooth>

You can access internet and other Bluetooth devices without connecting cables.

NOTE

- Communication is established through the Bluetooth antenna (A). Do not block the antenna area with your hand or body.

<CF-53 Series>

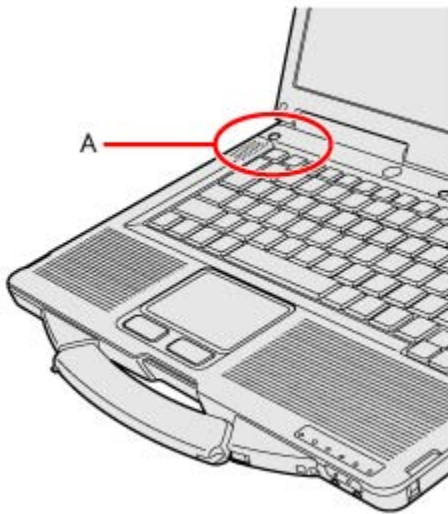

<CF-52 Series>

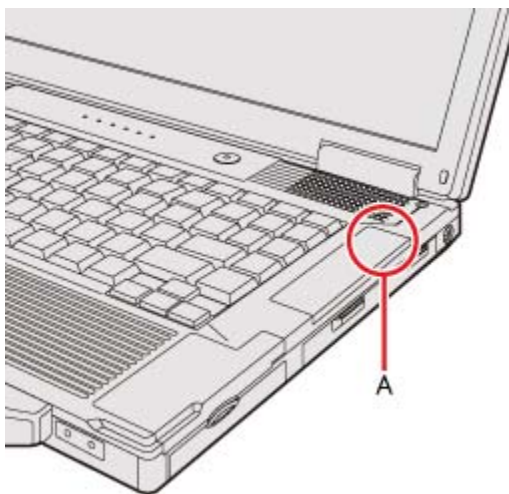

- To use Bluetooth, set **[Bluetooth]** to **[Enabled]** (default) in the **[Advanced]** menu of the Setup Utility.

- The transmission rate will be lower when a microwave oven is used near by.
 - It may take some time to turn off Bluetooth after switching the wireless switch to off.
 - When you uninstall the Bluetooth Driver, turn Bluetooth off.
-
-



Using the Bluetooth Function

Before using a Bluetooth, turn the Bluetooth communication on.

Turning on/off the Bluetooth communication

1. Slide the wireless switch to turn ON / OFF Bluetooth (➡ [The Wireless Switch](#)).
-

To check the Bluetooth communication status

1. Click  on the notification area and place the cursor over the Wireless Switch Utility icon ( or ).

A tooltip appears.

To access the online manual

1. Click  (Start)^{*1} - [All Programs] - [Bluetooth] - [Bluetooth User's Guide].

*1 : Windows XP: [start]

Wireless WAN

<Only for model with wireless WAN >

This computer is equipped with the Wireless WAN enabling you to communicate using radio frequencies.

Inserting/Removing a SIM Card

Before using the Wireless WAN, set a SIM card to the SIM card slot.

CAUTION

- Be sure to shut down the computer before inserting or removing the SIMcard.
-
-

NOTE

- Communication is established through the Wireless WAN antenna (A). Do not block the antenna area with your hand or body.

<CF-53 Series>

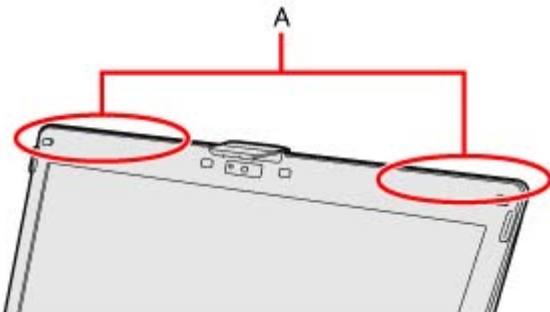

<CF-52 Series>

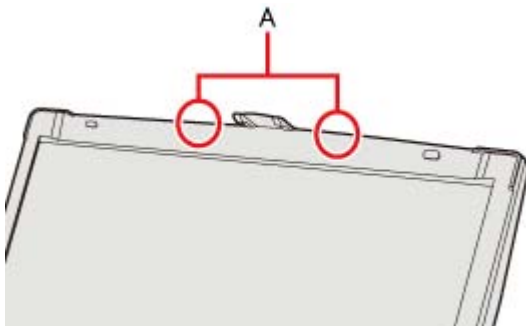

- <Only for CF-53 Series>

When you connect this computer to a port replicator compatible with external antenna, you can switch the internal antenna to the external antenna, or vice versa.

(→ [Wireless Antenna Switching](#))

To insert a SIM card

1. Turn off the computer.
2. Open the cover (B).

<CF-53 Series>

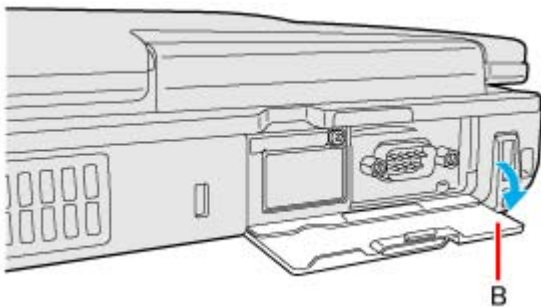

<CF-52 Series>

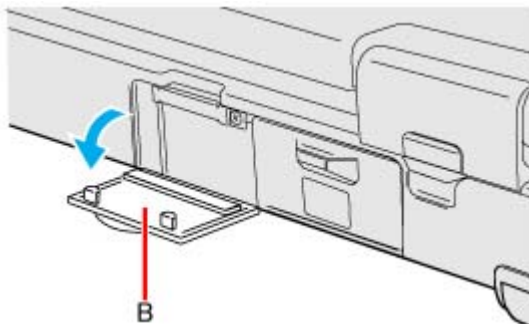

3. If there is a cover (D), remove a screw (C) and then remove the cover (D).

<CF-53 Series>

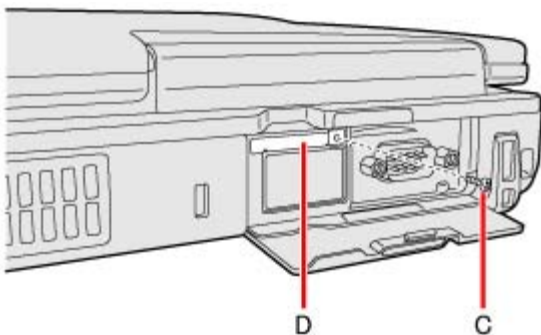

<CF-52 Series>

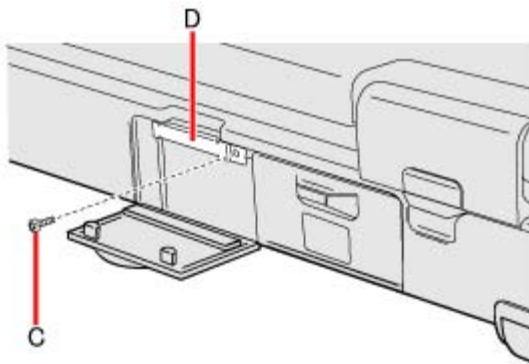

4. Insert the SIM card into the SIM card slot with the contact side facing down and the cut corner facing forward.

<CF-53 Series>

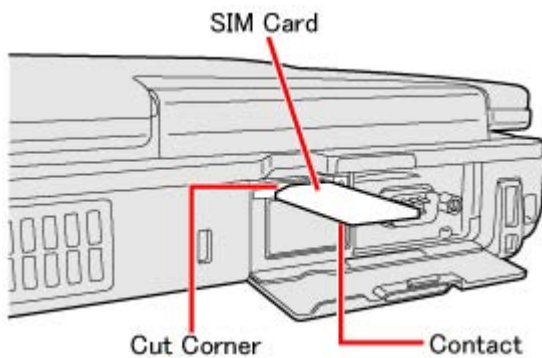

<CF-52 Series>

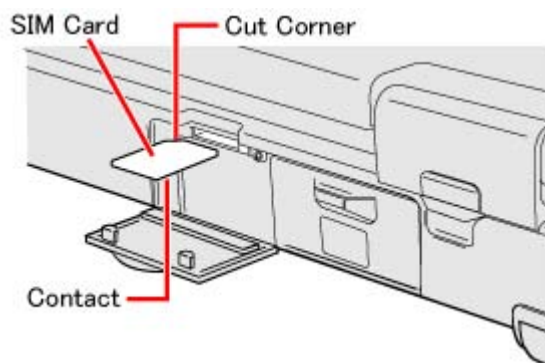

CAUTION

- Do not insert the SIM card upside down.
-

5. If there was the cover (D), attach the cover (D) and tighten the screw (C) firmly.

6. Close the cover (B).

To remove a SIM card

1. Turn off the computer.

2. If there is a cover (D), remove a screw (C) and then remove the cover (D).

<CF-53 Series>

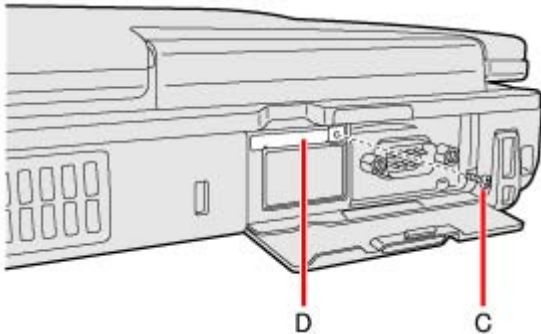

<CF-52 Series>

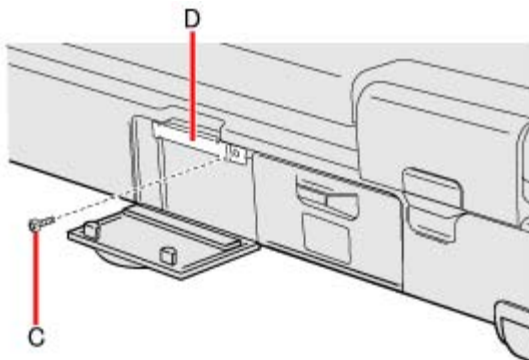

3. Push the card.

It will come out of the slot a little bit.

<CF-53 Series>

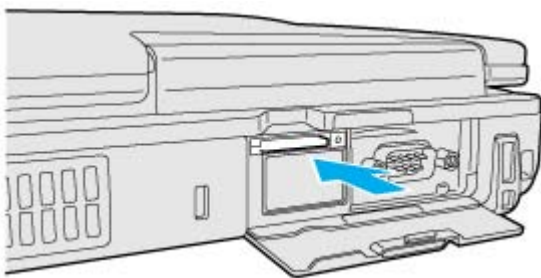

<CF-52 Series>

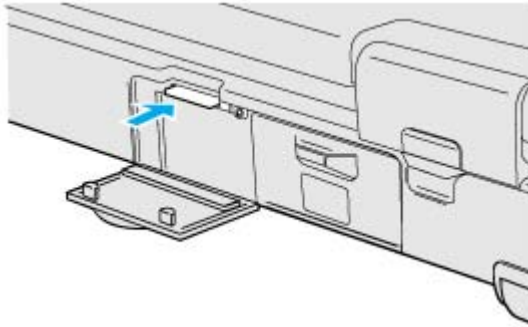

4. Pull the card all the way out.

<CF-53 Series>

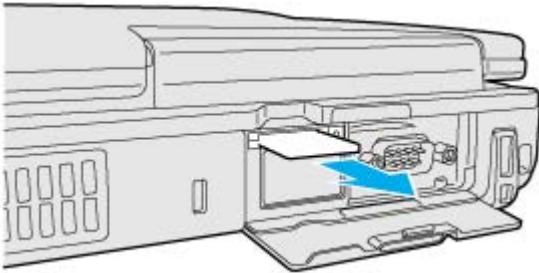

<CF-52 Series>

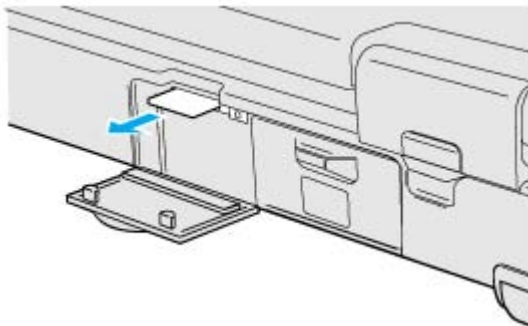

5. If there was the cover (D), attach it and tighten the screw (C) firmly.

<CF-53 Series>

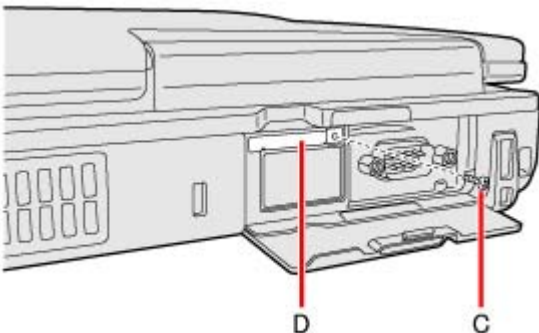

<CF-52 Series>

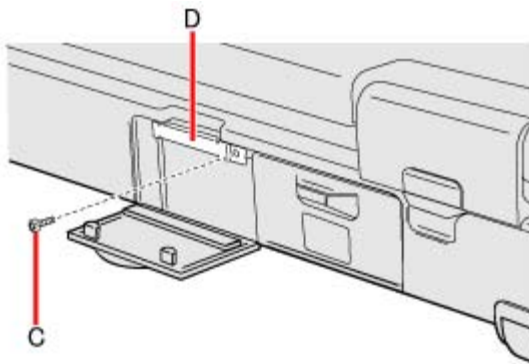

6. Close the cover (B).

<CF-53 Series>

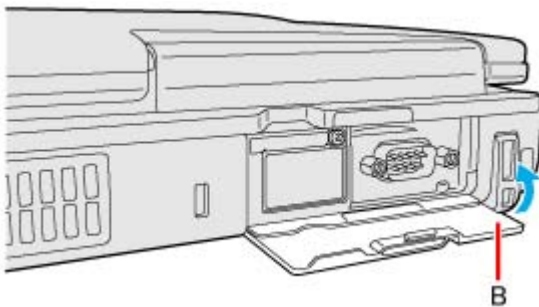

<CF-52 Series>

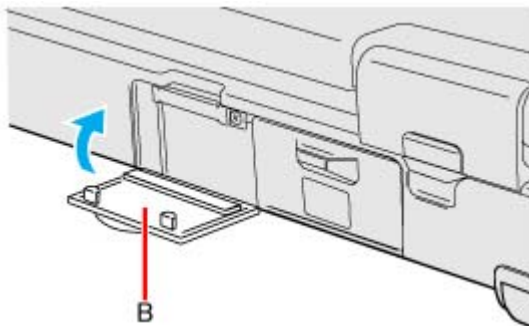

Wireless WAN Manager

When  is displayed on the desktop, you can use application software compatible with the built-in wireless WAN. For the using method of the application software, see on-line help using the following operation.

1. **Double-click**  **on the desktop.**

[Wireless WAN Manager] screen appears.

2. Click [Help].

Hard Disk Drive

Inserting/Removing the Hard Disk Drive

To change your hard disk drive, contact Panasonic Technical Support.

CAUTION

- **Back up all the important data before removing the hard disk drive.**
 - **If you need to read the hard disk data on another computer for repair or any other purpose, set [\[Hard Disk Lock\]](#) to [Disabled] in the [\[Security\]](#) menu of the [Setup Utility](#) before removing the hard disk drive.**
 - **Carefully remove/insert the hard disk drive since the hard disk drive is extremely sensitive to shock. Note that static electricity may affect some internal components.**
-

1. **Turn off the computer and disconnect the AC adaptor.**
 - Do not use sleep^{*1} or hibernation.
2. **Remove the Battery Pack ([▶ Replacing the Battery Pack](#)).**
3. **<CF-53 Series>**
Insert/Remove the hard disk drive.
 - To remove
 1. Slide and hold the latch (A).
 2. Pick up (B).
 3. Pull up carefully.The hard disk drive is attached behind the cover.

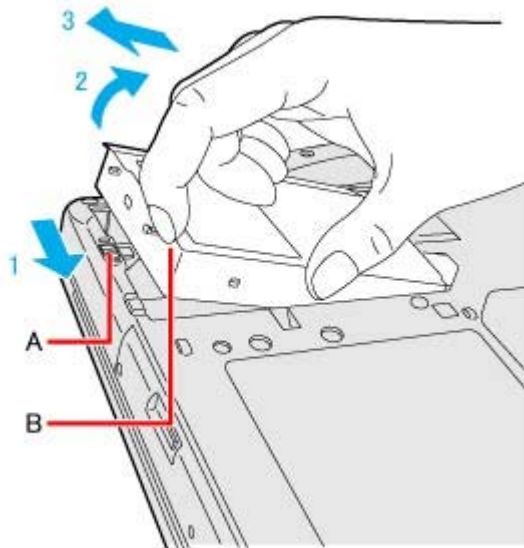

- **To insert**

Attach the hard disk drive until it clicks.

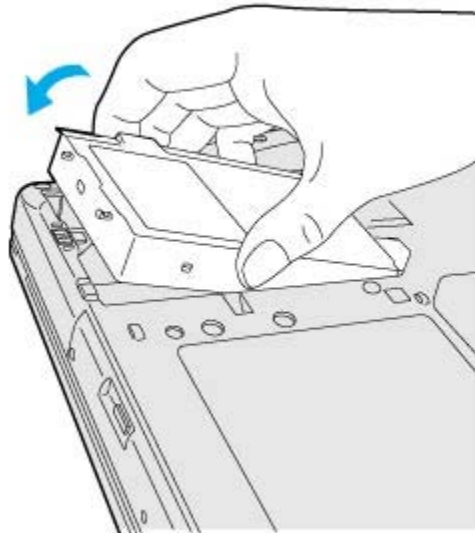

<CF-52 Series>

Insert/Remove the hard disk drive.

- **To remove**

Slide and hold the latch (A), and slide the cover (B) carefully.

The hard disk drive is attached behind the cover.

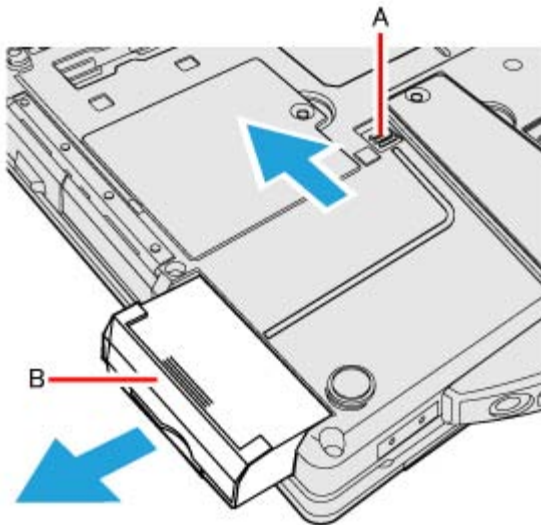

- To insert

Insert the hard disk drive until it clicks.

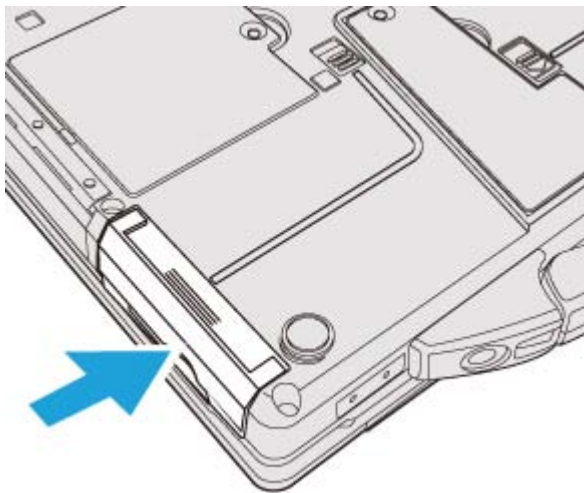

4. Insert the Battery Pack (➔ [Replacing the Battery Pack](#)).

*1 : Windows XP: standby

CAUTION

- Confirm that the latch is surely locked so that the hard disk drive does not fall when you carry the computer.
 - Be sure to attach the hard disk drive for use.
-

NOTE

-
- You can erase the data before changing the hard disk drive (➔ [Hard Disk Data Erase Utility](#)).
 - You can check that the hard disk is recognized or not in the [\[Information\]](#) menu of the Setup Utility. If the hard disk is not recognized, turn off the computer and insert it again.
-

Setup Utility

You can make the settings of the computer's operating environment (password settings, startup drive selection, etc.)

Starting the Setup Utility

1. Turn on or restart the computer.
2. Press «F2» or «Del» while [Panasonic] boot screen is displayed soon after the computer starts the startup procedure.

When [Enter Password] is displayed, enter your password.

When you start the Setup Utility with Supervisor Password

- You can make the settings of all items of the Setup Utility.

When you start the Setup Utility with User Password

- Note the following:
 - In the [Advanced] and [Boot] menus, you cannot make the settings of all items.
 - In the [Security] menu, you can change only the User Password when [User Password Protection] is set to [No Protection]. You cannot delete the User Password.
 - In the [Exit] menu, you cannot make the setting of [Load Default Values] and [Boot Override].
 - «F9» (Setup Defaults) does not function.

NOTE

- The [Panasonic] boot screen may not appear when only the external display is being used. In this case, as soon as the computer starts up, press «F2» or «Del» several times and start the Setup Utility.

Information Menu

Underlined items are the factory presets.

Language	<u>English</u> French
----------	--------------------------

	Japanese
--	----------

Product Information

Model No. Serial No.	Computer information (cannot be changed.)
-------------------------	--

System Information

Processor Type Processor Speed Memory Size Available Memory* ¹ Hard Disk	Computer information (cannot be changed.)
---	--

BIOS Information

BIOS BIOS Configuration Embedded Controller Intel(R) ME Firmware Accumulative Operating Time Access Level	Computer information (cannot be changed.)
--	--

*1 : When the mounted memory capacity is 4GB or less, Available Memory is 2GB.

When the mounted memory capacity is more than 4GB, Available Memory is 8GB (3239MB for 32bit OS)

Main Menu

Underlined items are the factory presets.

System Date • Day of the Week/Month/Day/Year. • You can use «Tab» to move the cursor.	[xxx xx/xx/xxxx]
System Time • 24-hr. style. • You can use «Tab» to move the cursor.	[xx:xx:xx]

Main Configuration

Touch Pad	Disabled <u>Enabled</u>

<p>Touchscreen Mode</p> <ul style="list-style-type: none"> Only for model with touchscreen. 	<p>Touchscreen Mode Table Mode <u>Auto</u></p>
<p>Current Status</p> <ul style="list-style-type: none"> Only when [Touchscreen Mode] is set to [Auto]. 	<p>Depending on the current status, either "Touchscreen Mode" or "Tablet Mode" is displayed.</p>
<p>10-Key Mode</p> <ul style="list-style-type: none"> Select the behavior of the 10-key area of the keyboard. When [NumLock] is selected, the 10-key area works as a number pad when NumLock LED is on. When [Fn Key] is selected, the 10-key area works as a number pad when the «Fn» key is held. 	<p><u>NumLock</u> Fn Key</p>
<p>Display</p> <ul style="list-style-type: none"> The display during the Windows start-up process. When an external display is not connected, the information appears on the internal LCD even though the [External Monitor] is selected. 	<p><u>External Monitor</u> Internal LCD</p>
<p>LCD Brightness Mode</p> <ul style="list-style-type: none"> Only for model with touchscreen. When [High Brightness] is selected, the brightness of the LCD is about twice that of [Normal Brightness] mode, and power consumption is also higher. 	<p>Normal Brightness <u>High Brightness</u></p>
<p>Battery Charging Indicator</p>	<p><u>On Continuous</u> Flashing</p>
<p>Power on AC</p>	<p><u>Disabled</u> Enabled</p>
<p>LID Switch</p>	<p>Disabled <u>Enabled</u></p>
<p>Wireless Antenna Switching</p> <ul style="list-style-type: none"> Only for CF-53 Series Only when the peripheral device with external antenna is connected. If [Auto] is selected, the external antenna is used when it is connected. If [PC (built-in)] is selected, the internal antenna is used. 	<p>PC (built-in) <u>Auto</u></p>
<p>Environment</p>	<p>Normal Temperature High Temperature <u>Auto</u></p>
<p>Current Status</p>	<p>Depending on the</p>

<ul style="list-style-type: none"> Only when [Environment] is set to [Auto]. 	battery status, either "Normal Temperature" or "High Temperature" is displayed.
---	---

▶ Concealed Mode Configuration	Enter the sub-menu. ^{*2}
--------------------------------	-----------------------------------

^{*2} : The submenu that appears when [Concealed Mode Configuration] is selected:

Concealed Mode	<u>Disabled</u> Enabled
LCD Backlight <ul style="list-style-type: none"> Can be changed only when [Concealed Mode] is set to [Enabled]. 	<u>ON</u> Minimum OFF
LED <ul style="list-style-type: none"> Can be changed only when [Concealed Mode] is set to [Enabled]. Except for the LED of external devices. 	<u>ON</u> OFF
Sound <ul style="list-style-type: none"> Can be changed only when [Concealed Mode] is set to [Enabled]. 	<u>ON</u> OFF
Wireless Radio <ul style="list-style-type: none"> Can be changed only when [Concealed Mode] is set to [Enabled]. 	<u>ON</u> OFF

▶ Fan Diagnostics <ul style="list-style-type: none"> Press «Enter» to start fan test. 	Enter the sub-menu.
--	---------------------

▶ Optical Kit Configuration	Enter the sub-menu.
-----------------------------	---------------------

Advanced Menu

Underlined items are the factory presets.

▶ CPU Configuration	Enter the sub-menu ^{*3} .
---------------------	------------------------------------

^{*3} : The submenu that appears when [CPU Configuration] is selected:

Execute-Disable Bit Capability	Disabled
--------------------------------	----------

<ul style="list-style-type: none"> [Enabled] indicates that this computer supports hardware-based Data Execution Prevention (DEP). 	<u>Enabled</u>
Intel(R) Hyper-Threading Technology	Disabled <u>Enabled</u>
Core Multi-Processing	Disabled <u>Enabled</u>
Intel(R) Virtualization Technology	Disabled <u>Enabled</u>
Intel(R) VT-d	<u>Disabled</u> Enabled
Intel(R) Trusted Execution Technology	<u>Disabled</u> Enabled
Intel(R) Turbo Boost Technology 2.0	Disabled <u>Enabled</u>

Peripheral Configuration

HDD Controller Setting <ul style="list-style-type: none"> Do not change this setting. If you do, the operating system will not function correctly. 	Compatible <u>AHCI</u>
Optical Drive	Disabled <u>Enabled</u>
Serial Port	Disabled <u>Enabled</u>
LAN	Disabled <u>Enabled</u>
Power On by LAN <ul style="list-style-type: none"> Can be changed only when [LAN] is set to [Enabled]. To use [Power On by LAN], make additional settings in [Device Manager]. 	<u>Deny</u> Allow
LAN (2nd) <ul style="list-style-type: none"> Only for model with 2nd LAN 	Disabled <u>Enabled</u>
Modem <ul style="list-style-type: none"> Only for model with Modem 	Disabled <u>Enabled</u>
▶ Wireless Configuration	Enters the sub-menu ^{*4} .

*4 : The submenu that appears when [Wireless Configuration] is selected:

Wireless Switch	Disabled <u>Enabled</u>
Wireless Ready Indicator	Disabled

	<u>Enabled</u>
Wireless LAN <ul style="list-style-type: none"> Only for model with wireless LAN [Wireless LAN/WiMAX] is displayed for the model with WiMAX. 	Disabled <u>Enabled</u>
Wireless WAN <ul style="list-style-type: none"> Only for model with wireless WAN 	Disabled <u>Enabled</u>
Bluetooth <ul style="list-style-type: none"> Only for model with Bluetooth 	Disabled <u>Enabled</u>

Upper Ext Antenna <ul style="list-style-type: none"> Only for CF-53 Series Only when the peripheral device with external antenna is connected. 	WWAN main WLAN sub <u>NONE</u>
Lower Ext Antenna <ul style="list-style-type: none"> Only for CF-53 Series Only when the peripheral device with external antenna is connected. 	WWAN sub WLAN main <u>NONE</u>
ExpressCard Slot <ul style="list-style-type: none"> Only for model with ExpressCard Slot 	Disabled <u>Enabled</u>
PC Card Slot	Disabled <u>Enabled</u>
Legacy Card Support	<u>Upper Slot</u> Lower Slot
SD Slot	Disabled <u>Enabled</u>
IEEE1394 Port <ul style="list-style-type: none"> Only for model IEEE1394 Port 	Disabled <u>Enabled</u>
Smart Card <ul style="list-style-type: none"> Only for model with Smart Card 	Disabled <u>Enabled</u>
USB Port	Disabled <u>Enabled</u>
Legacy USB Support	Disabled <u>Enabled</u>

Boot Menu

Underlined items are the factory presets.

Boot Mode	<u>Fast</u>
-----------	-------------

- Setting [Fast] will skip the [Panasonic] boot screen normally displayed immediately after the computer is turned on. The time required to display the Windows boot screen will become shorter.
Since the [Panasonic] boot screen is not displayed, press and hold «F2» or «Del» and turn the computer on to start the Setup Utility.
- If the startup from USB devices is not possible, set [Compatible] and retry. However, setting [Compatible] will require longer time to display the Windows boot screen than setting [Normal].

Normal
Compatible

Boot Option Priorities

Boot Option #1	USB Floppy Disk* ⁵
Boot Option #2	Hard Disk
Boot Option #3	Optical Drive
Boot Option #4	LAN
Boot Option #5	USB Hard Disk
Boot Option #6	USB Optical Drive

To change the boot order

The default order is [USB Floppy Disk*⁵] → [Hard Disk] → [Optical Drive] → [LAN] → [USB Hard Disk] → [USB Optical Drive].

- **Press «Enter» on the boot device you want to change and select the boot device from the following menu.**
 - When a selected boot device in the following menu already exists in either of the [Boot Option (#1 to #6)], the boot device appears at the newly selected position by switching the positions with the original boot device that existed before at the position.
 - When you select [Disabled] in the following menu, the disabled [Boot Option] is ignored and the boot device in the next [Boot Option] operates.

*5 : The operation is confirmed by Panasonic USB floppy disk drive (optional: CF-VFDU03U).

Security Menu

Underlined items are the factory presets.

Boot Prompt Configuration

Setup Utility Prompt <ul style="list-style-type: none"> When [Setup Utility Prompt] is set to [Disabled], the message "Press F2 for Setup / F12 for LAN" is not displayed on [Panasonic] boot screen. However, F2 and F12 will work even if the message is not displayed. 	Disabled <u>Enabled</u>
Boot Popup Menu	<u>Disabled</u> Enabled
Password On Boot	Disabled Enabled <u>Auto</u>
Password On Reboot	Disabled <u>Same as Boot</u>
Password On Resume	<u>Disabled</u> Enabled Auto
Boot Device On Hibernation Resume	Try prior devices <u>Hard Disk only</u>
Set Supervisor Password	Enter the sub-menu.
Hard Disk Lock <ul style="list-style-type: none"> Can be changed only when [Set Supervisor Password] is set. 	<u>Disabled</u> Enabled
User Password Protection	<u>No Protection</u> Protected
Set User Password	Enter the sub-menu.
Intel(R) Anti-Theft Technology	<u>Inactive</u> Active
Suspend mode transition	<u>Disabled</u> Enabled
▶ Embedded Security(TPM) <ul style="list-style-type: none"> Only for model that supports TPM For information on TPM, refer to the <i>Installation Manual</i> of "Trusted Platform Module (TPM)". <p>Windows 7</p> <p>Click  (Start), input "c:\util\drivers\tpm\readme.pdf" in [Search programs and files], and press «Enter».</p> <p>Windows XP</p>	Enter the sub-menu.

Click [start] - [Run] and input "c:\util\drivers\tpm\readme.pdf", and click [OK].	
►Fingerprint Security <ul style="list-style-type: none"> Only for model with Fingerprint Reader 	Enter the sub-menu.
►AMT Configuration <ul style="list-style-type: none"> Only for model that supports Intel(R) AMT 	Enter the sub-menu.
►Intel(R) Anti-Theft Technology <ul style="list-style-type: none"> Only for model that does not supports Intel(R) AMT 	Computer information (Cannot be changed)

Exit Menu

Save Values and Reboot	To reboot the system after saving the changes.
Reboot Without Saving Changes	To reboot the system without saving the changes.

Save Options

Save Current Values	To save the changes for all Setup options.
Load Previous Values	To load previous values for all Setup options.
Load Default Values	To return the settings to the default values.

Boot Override

(Device Information)	To select a boot device which operates only in the next booting.
►Repair Your Computer	View a list of system recovery tools you can use to repair startup problems, run diagnostics, or restore your system.
►Diagnostic Utility	Execute Diagnostic Utility.

Icon Enlarger

Windows XP

Enlarging the screen items

You can enlarge the screen items such as characters, icons, title bars and mouse cursor.

CAUTION

- "Icon Enlarger" will not start up if the display resolution is set lower than 1024 x 768 dots.

NOTE

- A part of the enlarged menu or some screen items may be hidden. In this case, overlay the cursor to display pop-ups, scroll the screen, or use other functions to display the hidden items.
- The Icon Enlarger setting affects the website characters displayed by Internet Explorer and the e-mail characters in Outlook Express. Some characters of website and e-mail may not be enlarged.

Preparation

Close all of the applications before using "Icon Enlarger".

1. Click [start] - [All Programs] - [Panasonic] - [Icon Enlarger].

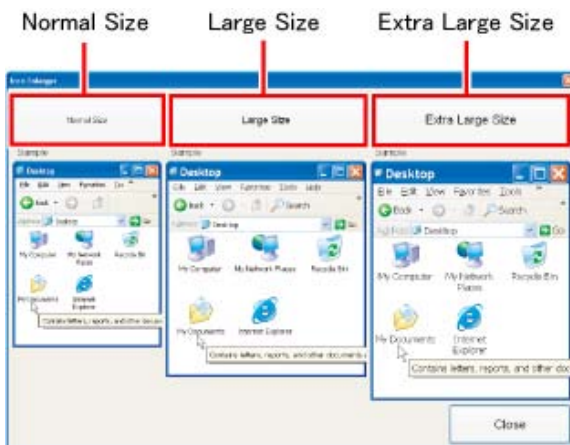

2. Select the size.
3. Click [OK].

The screen will be displayed in the selected size.



Loupe Utility

You can magnify the specific part of the screen.

Activating the Loupe Utility

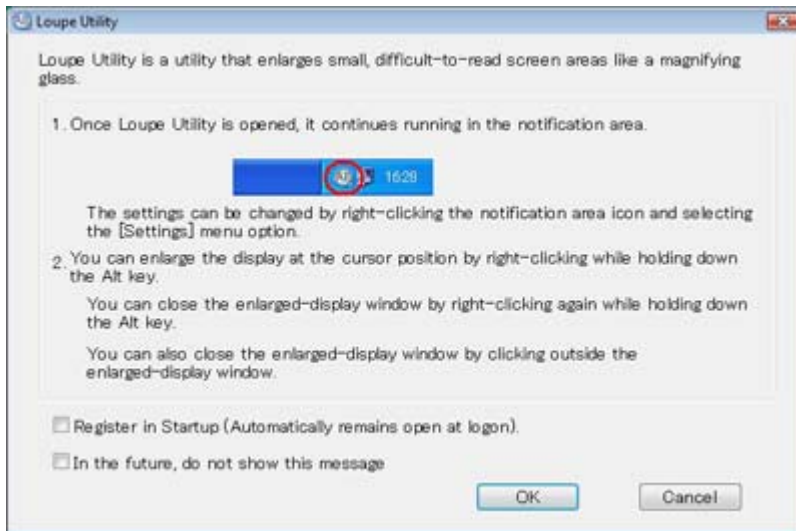



1. Click  (Start)*1 - [All Programs] - [Panasonic] - [Loupe Utility].



2. Click [OK].
 - o  appears on the notification area. If  does not appear on the area, click .

*1 : Windows XP: [start]

Using the Loupe Utility

1. Point the cursor  at the part of the screen you want to magnify.
2. Press and hold «Alt», and right-click.
 - o The part pointed by the cursor is magnified.
 - o Alternatively you can double-click , or right-click  and click [Show Loupe].
3. Drag the loupe window (A) to move the magnified part.
 - o To hide the loupe window, click the Hide button  (B).
Alternatively you can click any part out of the loupe window, or press and hold «Alt» and right-click.

- To change the loupe window size, drag the bottom-right corner (C).
The size range you can enlarge/shrink depends on the screen's resolution.

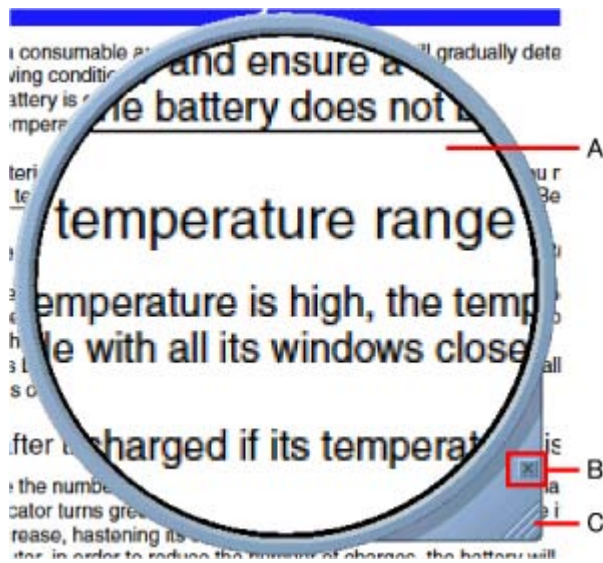

NOTE

- The magnified text or image in the loupe window is fixed at the moment that the part is magnified (e.g., at the moment you press and hold «Alt» and right-click). To reflect the change you made on the original screen to the loupe window, click the loupe window.
- The Loupe Utility does not work with some applications.

Setting the Loupe Utility

1. Click  on the notification area and right-click .
2. Click [Settings].

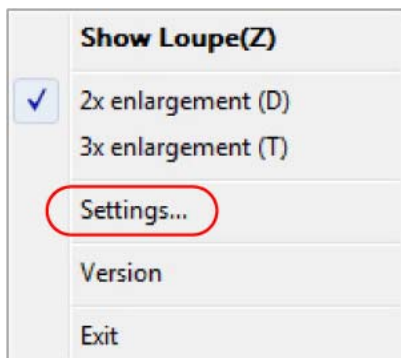

[Show/hide shortcuts assignment]

- When using the external mouse/touch pad

1. Click [Mouse / Touch pad]
 2. Click a combination of «Alt», «Ctrl», and «Shift», and add the check mark. (Multiple keys can be combined; for example, «Ctrl» + «Alt»)
 3. Click either [Right click] or [Left click] to use in combination with the key(s) selected in step 2 above.
- When using the keyboard
 1. Click [Keyboard].
 2. Click the text box and then press the key used for the shortcut.
(e.g., «Alt» + «Z», «Ctrl» + «Alt» + «Z», etc.)

[Window shape]

Select the shape of the loupe window.

[Autorun]

You can turn on/off autorun of the Loupe Utility and the explanation window.

3. Click [OK].

Hardware Diagnostics

If it appears that the hardware installed in this computer is not operating properly, you can use the PC-Diagnostic Utility to determine whether or not there is a problem.

If the utility discovers a problem in the hardware, contact Panasonic Technical Support.

Software cannot be checked using this utility.

Hardware that can be checked using the PC-Diagnostic Utility

- **CPU/Systems (check CPU)**
- **RAM XXX MB (check Memory)**
- **HDD XXX GB (check Hard Disk)**
- **DVD-ROM (check CD/DVD Drive)**
- **Video (check Video Controller)**
- **Sound^{*1}**
- **Modem (Only for model with Modem)**
- **LAN**
- **Wireless LAN (Only for model with wireless LAN)**
- **Wireless WAN (Only for model with wireless WAN)**
- **Bluetooth (Only for model with Bluetooth. When the wireless switch is not set to ON, it does not work.)**
- **USB^{*2}**
- **IEEE 1394 (Only for model with IEEE 1394 port)**
- **PC Card (check PC Card Controller)**
- **SD (check SD Card Controller)**
- **Express Card (Only for model with ExpressCard slot)**

- **Smart Card (Only for model with Smart Card slot)**
- **Serial Port**
- **Keyboard**
- **Touch Pad**
- **Touchscreen (Only for model with Touchscreen)**

*1 : When the PC-Diagnostics Utility is running a loud beep will sound, so do not use headphones as this time. (The beep will not sound if mute is using Windows or [Sound] is turned off in [Concealed Mode Configuration].)

*2 : The USB port for USB 3.0 (➔ [Connecting/Removing USB Devices](#)) cannot be checked using this utility.

- **When the video diagnostic check is running, the display may be distorted. This is not malfunction.**

Regarding the PC-Diagnostic Utility

NOTE

- For the hard disk and memory only, you can select standard diagnostic check or extended diagnostic check. When the PC-Diagnostic Utility starts up, it will run the standard diagnostic check.

- **We recommend that you use the touch pad for operations. When not using the touch pad, you can operate using the internal keyboard instead. Do not use the touchscreen.**

Operations	Touch pad operations	Internal keyboard operations
Select icon	Place the cursor above the icon	Press «Space», and then press «→»«←»«↑»«↓» (☒ (close) cannot be selected)
Click the icon	Tap or click (right click cannot be used)	Press «Space» above the icon
Complete the PC-Diagnostics Utility and then restart the computer	Click ☒(close)	Press «Ctrl» + «Alt» + «Del»

- **If the touch pad does not operate properly, press «Ctrl» + «Alt» + «Del» to restart the computer, or press the power switch to turn the power off, and then restart the PC-**

Diagnostic Utility.

Running the Diagnostic Check

Run this utility using the default settings in the Setup Utility.

If the Setup Utility or other settings will not allow hardware to be executed, the hardware icon will be displayed in gray.

1. Connect the AC adaptor, and turn on the wireless switch.

During the diagnostic check, do not remove the AC adaptor, or attach any peripheral devices.

2. Turn on or restart the computer, and press «F2» or «Del» while [Panasonic] boot screen is displayed.

The Setup Utility starts up.

- If the password is requested, enter the Supervisor Password.
- If you are using the computer after changing the settings from the status at the time of purchase, we recommend that you make a note of the settings that are changed.

3. Press «F9».

At the confirmation message, select [Yes] and press «Enter».

4. Press «F10».

At the confirmation message, select [Yes] and press «Enter».





The computer will restart.

5. While [Panasonic] boot screen is displayed, press and hold «Ctrl» + «F7» until "Please Wait" appears at the bottom of the display.

When the PC-Diagnostic Utility starts up, it will automatically begin the diagnostic check for all hardware components.

- If the password is requested, enter the password.
- The touch pad and the internal keyboard may not be used when each hardware checking is running. While checking, blue and yellow colors are displayed on the left side of the hardware icon (A).



- By clicking the icon, you can execute the following operations:
 -  : Start the diagnostic check from the beginning
 -  : Stop the diagnostic check (You cannot restart the check partway through by clicking )
 -  : Display help (click the screen or press «Space» to return to the original diagnostic check screen)
- You can check the status of the diagnostic check by the display color on the left side of the hardware icon (A).
 - Aqua: Not running diagnostic check
 - Alternating blue and yellow: Currently running diagnostic check. The interval of the alternating colors differs depending on the type of diagnostic check currently running.
During memory diagnostic check, the display may freeze for a long period of time. Wait until the process is complete.
 - Green: No problems discovered
 - Red: Problems discovered

NOTE

- Using the following procedure, you can run a diagnostic check on a specified hardware component, or run an extended diagnostic check on the memory or the hard disk (The extended diagnostic check is only for the memory and the hard disk). The extended diagnostic check is more detailed, and so requires a longer period of time to run.

1. Click  to stop the diagnostic check.
2. Click the icon for the hardware that is not to be checked, so that the icon is displayed in gray (B).



When running a check on the memory or the hard disk, clicking the icon once will turn on the extended diagnostic check ("FULL" (C) will be displayed below the icon); click again, and the icon will be displayed in gray (D).

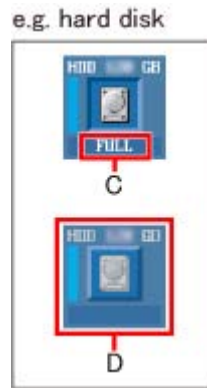

3. Click  to start the diagnostic check.

6. When all the hardware has been checked, confirm the diagnostic check results.

If the display is red and the message "Check Result TEST FAILED" is displayed, you can assume that there is a problem with the computer's hardware. Confirm which hardware component is displayed as red, and contact Panasonic Technical Support.

If the display is green and the message "Check Result TEST PASSED" is displayed, the computer's hardware is operating normally. Continue using the computer as it is. If the computer still does not operate properly, reinstall the software (➔ *OPERATING INSTRUCTIONS* "Reinstalling Software").

NOTE

- If you run a memory diagnostic check after installing a new RAM module (sold separately) and the message "Check Result TEST FAILED" is displayed: Remove the additional RAM module and run the diagnostic check again. If the message "Check Result TEST FAILED" is still displayed, you can assume that there is a problem with the internal RAM module.

7. After the diagnostic check is complete, click , or press «Ctrl» + «Alt» + «Del» to restart the computer.

NOTE

- You can also start the Diagnostic Check from [\[Diagnostic Utility\]](#) on the [\[Exit\]](#) menu of Setup Utility besides the method above.
-

· ʅ

Hard Disk Backup/Restore Function

Windows 7

[Create a system image] and [System Image Recovery] in [System Recovery Options] allow you create a backup of the entire hard disk data, which can be used to recover from hardware failure. This function creates a backup of the recent state of the hard disk. To return the factory default, use a recovery disc. (➔ [Recovery Disc Creation Utility](#))

Panasonic Corporation will bear no responsibility for any damage suffered (including loss of data) as a result of the use of this function.

Creating a Backup of the Hard Disk Data

To create a backup of the entire hard disk to another storage media (e.g., external hard disk). Follow the steps below.

1. Click  (Start) - [Control Panel] - [Back up your computer].
2. Click [Create a system image].
3. Select a location for backup and click [next].
Follow the on-screen instructions.

NOTE

- **Connect the AC adaptor and do not remove it until backup is complete.**

Restoring the Hard Disk Data

To restore the image data backed up using [Create a system image], use [System Image Recovery] in [System Recovery Options].

NOTE

- **This function does not work when you turn on the computer for the first time or just after you reinstall Windows.**
Start and shut down Windows 7, and then you can use the function.
 - **Connect the AC adaptor and do not remove it until restoration is complete.**
 - **If Windows does not start up, run [System Recovery Options] and then click [System Image Recovery] (➔ [Start up System Recovery Options](#)).**
-

-
1. Click  (Start) - [Control Panel] - [Back up your computer].
 2. Click [Recover system settings or your computer].
 3. Click [Advanced recovery methods].
 4. Click [Use a system image you created earlier to recover your computer].
 - A standard user needs to enter an administrator password.
 5. If you backup your files, click [Back up now].
 - If you do not backup your files, click [Skip].
 6. Click [Restart].
 - The computer will restart.
If [Enter Password] is displayed during the following procedure, input the Supervisor Password or the User Password.
 7. Click [Next].

Do not specify keyboard layouts other than the one already selected.
 8. If [Windows cannot find a system image on this computer] appears, connect to this unit the storage media (e.g. external hard disk) on which the system image has been backed up, and then click [Retry].
 9. Click [Next].

Follow the on-screen instructions.

Start up System Recovery Options

- **To perform from [Advanced Boot Options]**
 1. Turn on the computer, and when [Panasonic] boot screen disappears, press and hold «F8».
 - If [Enter Password] is displayed during the following procedure, input the Supervisor Password or the User Password.
 2. Release your finger when [Advanced Boot Options] is displayed.
 3. Press «↑» «↓» to select [Repair Your Computer] and press «Enter».
[System Recovery Options] appears.
 4. Click [Next].
 - Do not specify keyboard layouts other than the one already selected.
 5. Select the user name registered on Windows.

6. Input the password, then click [OK].

- **To perform from a recovery disc**

Before performing, you have to create a recovery disc. (➡ [Recovery Disc Creation Utility](#))

1. Turn off the computer.
2. Turn on the computer, and press «F2» or «Del» while [Panasonic] boot screen is displayed.
 - The Setup Utility starts up.
 - If the password is requested, enter the Supervisor Password.
3. Write down all of the contents of the Setup Utility and press «F9».
 - At the confirmation message, select [Yes] and press «Enter».
4. Press «F10».
 - At the confirmation message, select [Yes] and press «Enter».
 - The computer will restart.
5. Press «F2» or «Del» while [Panasonic] boot screen is displayed.
 - The Setup Utility starts up.
 - If the password is requested, enter the Supervisor Password.
6. Set the Product Recovery DVD-ROM Windows 7 into the CD/DVD drive.
7. Select the [Exit] menu, then select [Slimtype DVD...] in [Boot Override].
8. Press «Enter».
 - The computer will restart.
9. Click [Run "System Recovery Options"] and click [Next].
10. Click [Next].
 - Do not specify keyboard layouts other than the one already selected.
11. Follow the on-screen instructions.

· ʅ

Recovery Disc Creation Utility

Windows 7

You can make a recovery disc for Windows 7 Professional (32 bit or 64 bit).

The recovery disc returns the hard disk to the factory default. To create a backup of the recent state of the hard disk, refer to [Hard Disk Backup/Restore Function](#).

Preparation

- **About usable types of discs and required numbers of discs, refer to the screen.**
- **Prepare the Panasonic CD/DVD drive (included)**
- **Connect the AC adaptor and do not remove it until the operation is complete.**
- **Close all applications except for this utility.**

CAUTION

- **Do not perform the following operations until creating the recovery disc is complete.**

- Shut down or restart Windows.
 - Enter sleep or hibernation.
 - Change the drive letters for the CD/DVD drive.
-

1. **Log on to Windows as an administrator.**
2. **Set a disc into the CD/DVD drive.**
3. **Click  (Start) - [All Programs] - [Panasonic] - [Recovery Disc Creation Utility].**
If [User Account Control] is displayed, click [Yes].
4. **Click [Next].**
5. **Select OS (32 bit or 64 bit).**
6. **Click [Next].**
7. **Select the disc type.**
8. **Click [Next].**

9. When [Create recovery disc #1] is displayed, select [Write speed] and then click [OK].
10. When [Recovery disc #1 complete.] is displayed, remove the disc and write contents of the disc on the label side.

Do not use sharp objects that may leave a mark.
11. Click [OK].
12. Click [OK] on [All recovery discs complete.] screen.

If [All recovery discs complete.] screen does not appear, set a new disc that is same as the disc #1 and click [OK]. Then create all of recovery discs by following on-screen instructions.

NOTE

- The disc created with this utility is only for this computer. You cannot use for others.
 - Two or more users cannot use this utility with Windows Fast User Switching function.
 - Additional applications cannot be recovered even if you use a recovery disc created with this utility.
 - If you interrupted creating a recovery disc, a message of failure may appear in step 9 screen above. In this case, create a new recovery disc again.
 - You cannot successively create some recovery discs with this utility. To create another recovery disc, perform "System Recovery Options" beforehand. In this case, you can use the disc previously created with this utility.
 - If you fail to create a recovery disc or a error message appears, try either of the following procedures.
 - Insert the disc correctly.
 - Check the disc condition. (➡ [Disc handling care](#))
 - Restart the computer and try to create a recovery disc again.
 - Contact Panasonic Technical Support.
 - When you reinstall OS using the recovery disc, OS which was installed as the factory default will be installed. To change OS from 32 bit to 64 bit, or vice versa, reinstall OS using the recovery partition in the hard disk. (➡ **OPERATING INSTRUCTIONS** "Reinstalling Software")
-

Hard Disk Data Erase Utility

Windows 7

When disposing the computer or transferring the ownership, erase all hard disk data in order to avoid data leakage. Even if you erase the data or initialize the hard disk using normal Windows commands, the data can be read with some special software. Use the hard disk data erase utility to erase the data completely.

Note that transferring of the ownership without uninstalling the commercial software will be a violation of the software's license agreement.

The hard disk data erase utility erases data using an overwriting method, but there is a possibility that due to malfunctions or other operational errors, data may not be completely erased. There are also specialized devices that may be able to read data that has been erased using this method. If you need to erase highly confidential data, we recommend that you contact a company that specializes in this process. Panasonic Corporation will bear no responsibility for losses or damages suffered as a result of the use of this utility.

NOTE

- **Even if hard disk data erase is performed, the number of times of DVD's region code setting will not be reset.**
 - **This utility cannot erase data for specific partitions. However, the entire hard disk data including the data of the partition with recovery tools will be erased.**
-

Preparation

- **Remove all peripherals.**
- **Connect the AC adaptor and do not remove it until hard disk data erase is complete.**

1. **Turn off the computer.**
2. **Turn on the computer, and press «F2» or «Del» while [Panasonic] boot screen is displayed.**

The Setup Utility starts up.

- If the password is requested, enter the Supervisor Password.
3. **Select [Repair Your Computer] in [Exit].**
 4. **Click [Erase the whole data on the Hard Disk for security] and click [Next].**

5. **At the confirmation message, click [YES].**
6. **Click [Continue].**
7. **Click [Continue] again.**
8. **Click [YES].**
Erasing the hard disk data starts.
9. **After erasing is completed, click [OK].**

• y

Technical Information

Network Connections and Communications Software

Close the communications software before using the power saving function.

- If the power saving function (sleep^{*1} or hibernation) is activated while communications software is used, the network connection may be interrupted, or the performance may be adversely affected. In this case, restart the computer.

- **Windows 7**

In a network environment, set [Never] for [Put the computer to sleep] and [Hibernate after] (➔ [Setting Sleep or Hibernation](#)).

- **Windows XP**

In a network environment, set the [System standby] and [System hibernates] settings to [Never].

Click [Start] - [Control Panel] - [Performance and Maintenance] - [Power Options] - [Power Schemes].

*1 : Windows XP: standby

About Windows-related files

The Windows files included in the Windows DVD-ROM are contained in the following folders:

- **Windows 7**

<For localized OS model>

c:\windows\support\migwiz, c:\windows\support\tools, c:\windows\support\logging

<For MUI(Multilanguage User Interface) OS model>

- Some languages are not available depending on the model.

English

c:\windows\support\en\migwiz, c:\windows\support\en\tools, c:\windows\support\en\logging

Dutch

c:\windows\support\nl\migwiz, c:\windows\support\nl\tools, c:\windows\support\nl\logging

Finnish

c:\windows\support\fi\migwiz, c:\windows\support\fi\tools, c:\windows\support\fi\logging
French
c:\windows\support\fr\migwiz, c:\windows\support\fr\tools, c:\windows\support\fr\logging
German
c:\windows\support\de\migwiz, c:\windows\support\de\tools, c:\windows\support\de\logging
Italian
c:\windows\support\it\migwiz, c:\windows\support\it\tools, c:\windows\support\it\logging
Norwegian
c:\windows\support\no\migwiz, c:\windows\support\no\tools, c:\windows\support\no\logging
Russian
c:\windows\support\ru\migwiz, c:\windows\support\ru\tools, c:\windows\support\ru\logging
Spanish
c:\windows\support\es\migwiz, c:\windows\support\es\tools, c:\windows\support\es\logging
Swedish
c:\windows\support\sv\migwiz, c:\windows\support\sv\tools, c:\windows\support\sv\logging
Turkish
c:\windows\support\tr\migwiz, c:\windows\support\tr\tools, c:\windows\support\tr\logging
Arabic
c:\windows\support\ar\migwiz, c:\windows\support\ar\tools, c:\windows\support\ar\logging
Bulgarian
c:\windows\support\bg\migwiz, c:\windows\support\bg\tools, c:\windows\support\bg\logging
Chinese-Hong Kong
c:\windows\support\b3\migwiz, c:\windows\support\b3\tools, c:\windows\support\b3\logging
Chinese-Simplified
c:\windows\support\xt\migwiz, c:\windows\support\xt\tools, c:\windows\support\xt\logging
Chinese-Traditional
c:\windows\support\zh\migwiz, c:\windows\support\zh\tools, c:\windows\support\zh\logging
Croatian
c:\windows\support\yx\migwiz, c:\windows\support\yx\tools, c:\windows\support\yx\logging
Czech
c:\windows\support\cs\migwiz, c:\windows\support\cs\tools, c:\windows\support\cs\logging
Danish
c:\windows\support\da\migwiz, c:\windows\support\da\tools, c:\windows\support\da\logging
Estonian
c:\windows\support\et\migwiz, c:\windows\support\et\tools, c:\windows\support\et\logging
Greek
c:\windows\support\el\migwiz, c:\windows\support\el\tools, c:\windows\support\el\logging
Hebrew
c:\windows\support\iw\migwiz, c:\windows\support\iw\tools, c:\windows\support\iw\logging
Hungarian
c:\windows\support\hu\migwiz, c:\windows\support\hu\tools, c:\windows\support\hu\logging
Japanese

c:\windows\support\ja\migwiz, c:\windows\support\ja\tools, c:\windows\support\ja\logging

Korean

c:\windows\support\ko\migwiz, c:\windows\support\ko\tools, c:\windows\support\ko\logging

Latvian

c:\windows\support\lv\migwiz, c:\windows\support\lv\tools, c:\windows\support\lv\logging

Lithuanian

c:\windows\support\lt\migwiz, c:\windows\support\lt\tools, c:\windows\support\lt\logging

Polish

c:\windows\support\pl\migwiz, c:\windows\support\pl\tools, c:\windows\support\pl\logging

Portuguese

c:\windows\support\pt\migwiz, c:\windows\support\pt\tools, c:\windows\support\pt\logging

Portuguese (Brazilian)

c:\windows\support\xc\migwiz, c:\windows\support\xc\tools, c:\windows\support\xc\logging

Romanian

c:\windows\support\ro\migwiz, c:\windows\support\ro\tools, c:\windows\support\ro\logging

Serbian

c:\windows\support\st\migwiz, c:\windows\support\st\tools, c:\windows\support\st\logging

Slovak

c:\windows\support\sk\migwiz, c:\windows\support\sk\tools, c:\windows\support\sk\logging

Slovenian

c:\windows\support\sl\migwiz, c:\windows\support\sl\tools, c:\windows\support\sl\logging

Thai

c:\windows\support\th\migwiz, c:\windows\support\th\tools, c:\windows\support\th\logging

Ukrainian

c:\windows\support\uk\migwiz, c:\windows\support\uk\tools, c:\windows\support\uk\logging

Windows XP

c:\windows\docs, c:\windows\dotnetfx, c:\windows\i386, c:\windows\support, c:\windows\valueadd

Error Message

Follow the instructions below when an error message appears. If the problem persists or if the error message is not shown here, contact Panasonic Technical Support.

Error Message	Solution
Bad System CMOS	An error has occurred in the memory of system settings. This occurs when the memory content is changed by an unexpected program operation, etc.
System CMOS Checksum Error	<ul style="list-style-type: none">• Start the Setup Utility and return the settings to the default values, and then change the settings as necessary.• If the problem persists, the internal clock battery may need to be replaced. Contact Panasonic Technical Support.
Invalid Year. System date restored to 01/01/20XX	The date and time settings are not correct. <ul style="list-style-type: none">• Start the Setup Utility and set the correct date and time.• If the problem persists, the internal clock battery may need to be replaced. Contact Panasonic Technical Support.
Press <F2> to enter setup	<ul style="list-style-type: none">• Write down the error details and press «F2» or «Del» to start the Setup Utility. Change the settings if necessary.

Troubleshooting (Advanced)



Refer to the following instructions when a problem occurs. If the remedies indicated in the chart do not solve the problem, contact Panasonic Technical Support. For a software problem, refer to the instruction manual of the software.

- Refer to [Check the Computer's Usage Status](#).

Shut Down

<p>Cannot shut down or restart Windows.</p>	<ul style="list-style-type: none"> • Remove USB devices. • It may take 1 or 2 minutes to shut down.
---	---

Display

<p>The screen does not become bright even if pressing «Fn» + «F2».</p>	<ul style="list-style-type: none"> • The brightness is set low to avoid malfunction where surrounding temperature is high. Use it in an environment of between 5°C and 35°C.
<p>Windows 7 Takes time to display [Power Options] screen.</p>	<ul style="list-style-type: none"> • With the following steps, confirm whether [Copy of Panasonic Power Management] created when the Power Saving Utility is made has become 100 and more or not. <ol style="list-style-type: none"> 1. Click  or  on the notification area and click [More power options]. 2. Click [Show additional plans]. <p>When more than one [Copy of Panasonic Power Management] is displayed, click [Change plan settings] in the power plan to be deleted and click [Delete this plan] to delete.</p>
<p>The [Panasonic] boot screen is not displayed on the external display.</p>	<ul style="list-style-type: none"> • As soon as the computer starts up, press «F2» or «Del» several times and start the Setup Utility.
<p>There are red, green, or blue dots on the screen, or there is unevenness in colors and brightness on the screen.</p>	<p>The following are not malfunctions.</p> <ul style="list-style-type: none"> • Although advanced high-precision technologies are used in the production of color LCD screens, 0.002% or less of the picture elements may be dark or remain constantly lit (i.e., more than 99.998% of elements function properly). • Due to the natural characteristics of LCD screens, you may notice unevenness in colors and brightness depending on your angle of

	view. Hues may also vary by product.
--	--------------------------------------



Sleep*1 and Hibernation

Cannot enter sleep*1 or hibernation.	<ul style="list-style-type: none"> Remove USB devices temporarily. If the problem persists, restart the computer. It may take 1 or 2 minutes to enter sleep*1 or hibernation. The computer may not enter sleep*1 when the computer is communicating via modem. The computer does not enter sleep*1 or hibernation immediately after resuming. Wait approximately 1 minute.
Cannot enter sleep*1 or hibernation automatically.	<ul style="list-style-type: none"> Disconnect peripheral devices. If you connect to a network using wireless LAN function, select the profile and connect to the access point (➡ Setting the wireless LAN access point). If you do not use wireless LAN function, turn off wireless LAN function (➡ Turning on/off the wireless LAN communication). Make sure that you are not using any software that regularly accesses the hard disk.
The computer does not resume.	<ul style="list-style-type: none"> If you press and hold the power switch for 4 seconds or longer, the power will be turned off forcibly and the computer will not resume. In this case, all unsaved data will be lost. You disconnected the AC adaptor and the battery pack while the computer was in sleep*1. If the computer's power supply is disconnected in sleep*1, unsaved data will be lost and the computer will not resume. The battery is exhausted. Sleep*1 and hibernation consume some power.

*1 : Windows XP: standby



Sound

No sound.	<ul style="list-style-type: none"> Press «Fn» + «F4» or «Fn» + «F6» to cancel mute. Press «Fn» + «F8» to turn off the concealed mode. Restart the computer.
Distorted sound.	<ul style="list-style-type: none"> Performing «Fn» key combinations sometimes causes sound distortion. Stop and restart playback.

<p>Cannot change the volume by pressing «Fn» + «F5» or «Fn» + «F6».</p>	<ul style="list-style-type: none"> • Activate the Windows sound function. When it is not active, the volume does not change even if  is displayed.
<p>Can not record with microphone</p>	<ul style="list-style-type: none"> • Use a condenser microphone. • Some settings may have to be made depending on the microphone. <p>When using a monaural microphone with a 2-terminal plug:</p> <p>Windows 7</p> <ol style="list-style-type: none"> 1. Click  (Start) - [Control Panel] - [Hardware and Sound] - [Sound] - [Recording] - [Microphone] - [Enhancements], and then add a check mark for [Mono Microphone]. <p>Windows XP</p> <ol style="list-style-type: none"> 1. Click [Start] - [Control Panel] - [Sound, Speech, and Audio Device] - [Sounds and Audio Devices] - [Audio], and click [Volume] in "Sound recording". 2. Click [Options] and add a check mark for [Advanced Control]. 3. Click [Advanced] in "Mic Volume" and add a check mark for [2 Mono Mic], then click [Close]. <p>When recording in stereo using a stereo microphone:</p> <p>Windows 7</p> <ol style="list-style-type: none"> 1. Click  (Start) - [Control Panel] - [Hardware and Sound] - [Sound] - [Recording] - [Microphone] - [Enhancements], and then remove a check mark for [Mono Microphone]. <p>Windows XP</p> <ol style="list-style-type: none"> 1. Click [Start] - [Control Panel] - [Sound, Speech, and Audio Device] - [Sounds and Audio Devices] - [Audio], and click [Volume] in "Sound recording". 2. Click [Options] and add a check mark for [Advanced Control]. 3. Click [Advanced] in "Mic Volume" and remove a check mark for [2 Mono Mic], then click [Close].
<p>Windows 7 When logging on (e.g., resuming the computer), audio is distorted.</p>	<ul style="list-style-type: none"> • Perform the following steps to change the audio settings to prevent audio output. <ol style="list-style-type: none"> 1. Right-click the desktop and click [Personalize] - [Sounds].

	2. Remove the check mark from [Play Windows Startup sound].
<p>Windows XP</p> <p>"There was an error updating the registry" appears when Sound Recorder is started.</p>	<ul style="list-style-type: none"> • Sound Recorder is started by a limited account user whose language setting is not the same as the administrator user who last started Sound Recorder. This does not affect the operation.

Keyboard

Only numbers can be input.	<ul style="list-style-type: none"> • When the indicator  is on, the keyboard is in ten-key mode. Press «NumLk» to cancel.
Only capital letters can be input.	<ul style="list-style-type: none"> • When the indicator  is on, the keyboard is in Caps Lock mode. Press «Caps Lock» to cancel.
Cannot enter special characters (ß, à, ç, etc.) and symbols.	<ul style="list-style-type: none"> • Use the character map. Click  (Start)^{*2} - [All Programs] - [Accessories] - [System Tools] - [Character Map].

*2 : Windows XP: [start]

Disc Operation

The CD/DVD drive does not work normally.	<ul style="list-style-type: none"> • Set [Optical Drive] to [Enabled] in the [Advanced] menu of the Setup Utility. • Clean the lens (➡ CD/DVD drive handling care). • Check the disc condition (➡ Disc handling care).
Cannot play back TV programs recorded on a commercial DVD recorder.	<ul style="list-style-type: none"> • Finalize the disc on the DVD recorder when the program was recorded in video mode on DVD-R/RW or in VR mode on DVD-RW.
A blue background appears on the screen when playing an MPEG image.	<ul style="list-style-type: none"> • You opened the CD/DVD drive or removed the MPEG disc while it was operating. Re-insert the MPEG disc and close the CD/DVD drive.
The CD/DVD drive vibrates excessively or makes noise.	<ul style="list-style-type: none"> • Insert the disc correctly. • Check the disc condition (➡ Disc handling care). • When writing to CD-R/RW using Roxio Creator LJB, you can minimize vibration while writing by using the writing speed at [10x] or less.
Cannot eject a disc.	<ul style="list-style-type: none"> • Turn on the computer.

To remove a disc when the computer is powered off, insert a pin of 1.3 mm {0.05± in diameter into the emergency hole (A). (When the diameter of the pin is smaller than this, insert the pin slightly downward.) Pushing it completely to the end will free the tray so that it can be pulled out.

<CF-53 Series>

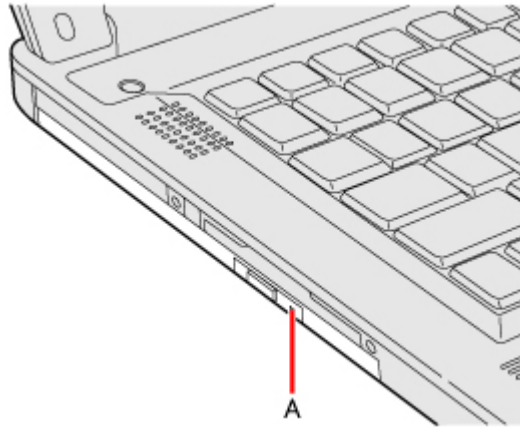

<CF-52 Series>

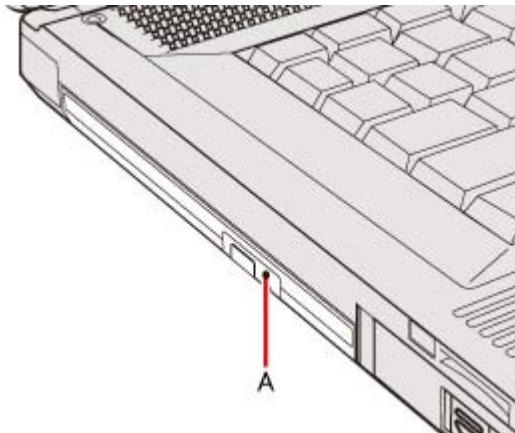

If a disc with fingerprints or other dirt is used, you may not be able to remove it. Use a clean disc. (➡ [To clean discs](#))

The disc tray does not close.

- Do not touch the eject button when closing the tray.

Other disc operation problems.

- Use another drive or media.

Network

Cannot connect to a















- Set [\[LAN\]](#) / [\[Modem\]](#) to [Enabled] in the [Advanced] menu of the

network.	Setup Utility.
Cannot check the computer's MAC address.	<ul style="list-style-type: none"> • Follow the steps below. <ol style="list-style-type: none"> 1. Click  (Start)^{*3} - [All Programs] - [Accessories] - [Command Prompt]. 2. Windows 7 Input "getmac /fo list /v", and press «Enter». <ul style="list-style-type: none"> ▪ Insert a space between "fo" and "list", and between "list" and "/v". Windows XP Input "ipconfig /all", and press «Enter». 3. Wireless LAN's MAC address: Make a note of the 12-digit string of alphanumeric displayed on "Physical Address" line of "Wireless Network Connection". Wired LAN's MAC address: Make a note of the 12-digit string of alphanumeric displayed on "Physical Address" line of "Local Area Connection". 4. Input "exit", and press «Enter».

*3 : Windows XP: [start]



Wireless Communication (only for model with wireless LAN/Bluetooth/wireless WAN)

Cannot connect to a network.	<ul style="list-style-type: none"> • Slide the wireless switch to turn on the wireless devices. • Set the device ([Wireless LAN] / [Bluetooth] / [Wireless WAN]) to [Enabled] in the [Advanced] menu of the Setup Utility (➔ Wireless Configuration). • Disable the Wireless Connection Disable Utility. • Restart the computer.
Access point is not detected.	<ul style="list-style-type: none"> • Shorten the distance between the computer and the access point, and try the detection again. • Windows 7 Confirm the following settings: <ul style="list-style-type: none"> ○ Wireless LAN in the [Advanced] menu of the Setup Utility Confirm that [Wireless LAN] is set to [Enabled]. ○ Wireless Switch Slide the wireless switch to ON.

	<ul style="list-style-type: none"> ○ Wireless Switch Utility Confirm that Wireless LAN is ON. <p>Windows XP</p> <p><Only for model with Intel® Centrino® Advanced N-6205> Confirm that  /  /  is displayed on the notification area. If  /  /  is not displayed on the notification area, turn on the wireless communication (➡ Turning on/off the wireless LAN communication).</p> <p><Only for model with Atheros AR928X> Confirm that  /  /  /  is displayed on the notification area. If  /  /  /  is not displayed on the notification area, turn on the wireless communication (➡ Turning on/off the wireless LAN communication).</p> <ul style="list-style-type: none"> ● This computer uses channels 1 through 11*4 when using IEEE802.11b/g. Check the channel being used by the access point.
<p><Only for model with wireless WAN> Cannot communicate.</p>	<ul style="list-style-type: none"> ● Confirm that wireless switch is in ON. ● Confirm that [Wireless WAN] is set to [Enabled] in the [Advanced] menu of the Setup Utility. ● Use the Wireless Switch Utility and confirm that the wireless WAN is on. ● Confirm that the SIM card is inserted correctly. <p>If communication is not established after proceeding with the above remedies, the wireless WAN device may not be correctly recognized. Restart the computer.</p>
<p><Only for model with wireless WAN> Windows 7 Cannot connect to the mobile broadband network.</p>	<p>When you connect to the mobile broadband network for the first time, proceed as follows.</p> <ol style="list-style-type: none"> 1. Click  to open [Connect to a Network], select [Mobile Broadband Network] and then click [Connect]. A message appears to show that connection has failed. 2. Right-click [Mobile Broadband Network] and select [Properties]. 3. Set the APN, user name and password. 4. Repeat step 1.

*4 : In the case of wireless communications, the frequency band being used can be divided into segments, so that different communications can be conducted on each band segment. A "Channel" refers to the individual frequency bandwidth divisions.

Connecting Peripherals

<p>An error occurs while installing the driver.</p>	<ul style="list-style-type: none"> • When you install a driver of card or peripheral device, make sure that the driver is compatible with the operating system. If it is not compatible, malfunction may occur. For information about the driver, contact the manufacturer of the peripheral device.
<p>A peripheral device does not work.</p>	<ul style="list-style-type: none"> • Install the driver. • Contact the manufacturer of the device. • When operation resumes from sleep^{*5} or hibernation, devices such as a mouse, modem and cards may not function properly. In this case, restart the computer or reinitialize the device. • When  or  is displayed in the Device Manager, remove and insert the device. If the problem persists, restart the computer. • When you set [USB Port] to [Disabled] in the [Advanced] menu of the Setup Utility, USB ports of port replicator are also disabled. • The computer may not recognize the connection/removal of some devices, or may not operate normally with some devices. <ol style="list-style-type: none"> 1. Windows 7 Click  (Start) - [Computer] - [System properties] - [Device Manager]. Windows XP Click [start] - [Control Panel] - [Performance and Maintenance] - [System] - [Hardware] - [Device Manager]. 2. Select the device, and remove the check mark for [Allow the computer to turn off this device to save power] in [Power Management]. (This item may be unavailable for some types of devices.) • In the case that a USB device does not work, remove the USB device and connect it again or connect the USB device to another port.
<p>The connected mouse does not work.</p>	<ul style="list-style-type: none"> • Check the mouse connection. • Install the driver compatible with the connected mouse. If the mouse does not work even after installing the driver, set [Touch Pad] to [Disabled] in the [Main] menu of the Setup Utility.
<p>USB floppy disk drive does not work as a boot drive.</p>	<ul style="list-style-type: none"> • The operation is confirmed by Panasonic CF-VFDU03U USB floppy disk drive (optional). • Connect the floppy disk drive directly to a USB port of the



	<p>computer. Do not connect it via a USB hub or USB connector of the port replicator. If you have connected to a USB port on the computer, try connecting it to one of the other USB ports.</p> <ul style="list-style-type: none"> • Set [USB Port] and [Legacy USB Support] to [Enabled] in the [Advanced] menu of the Setup Utility. • Set [Boot Option #1] to [USB Floppy Disk] in the [Boot] menu of the Setup Utility. • Turn off the computer and connect the USB floppy disk drive, and then restart the computer.
<p>The RAM module is not recognized.</p>	<ul style="list-style-type: none"> • Insert the RAM module correctly. • Use the compatible RAM module (➔ RAM Module). • Check the [Information] menu in the Setup Utility. If the RAM module is not recognized, turn off the computer and reinsert the RAM module.
<p>You do not know the address map for IRQ, I/O port address, etc.</p>	<ul style="list-style-type: none"> • Windows 7 <p>You can check with the following procedure.</p> <ol style="list-style-type: none"> 1. Click  (Start) - [Computer] - [System properties] - [Device Manager]. <ul style="list-style-type: none"> ▪ A standard user needs to enter an administrator password. 2. Click [View] - [Resources by type]. <ul style="list-style-type: none"> • Windows XP <p>To check the current address map, click [Start] - [Control Panel] - [Performance and Maintenance] - [System] - [Hardware] - [Device Manager] - [View] - [Resources by type].</p>
<p>The device connected to the serial port does not work.</p>	<ul style="list-style-type: none"> • Check the connection. • The device driver may not work. Refer to the instruction manual of the device. • Do not connect 2 mouse devices simultaneously. • Set [Touch Pad] to [Disabled] in the [Main] menu of the Setup Utility. • Set [Serial Port] to [Enabled] in the [Advanced] menu of the Setup Utility.
<p>Cannot print.</p>	<ul style="list-style-type: none"> • Check the printer connection. • Turn on the printer. • The printer is not online. • No paper is in the printer tray or there is a paper jam.

	<ul style="list-style-type: none"> • Turn on the printer and connect it to the computer, and then restart the computer. • Check the network connection if the printer is connected via network.
<p>LAN transmission speed slows down noticeably. Poor performance during data transmission via a PC Card (e.g., distorted video image when writing to a DV camera using an IEEE1394 PC Card). <Only for model with wireless LAN> Wireless LAN connection is cut.</p>	<p>Windows 7</p> <ul style="list-style-type: none"> • Try the following settings. Click  (Start) - [Control Panel] - [System and Security] - [Power Options], and select [High performance], then close the window. <p>Windows XP</p> <ul style="list-style-type: none"> • These problems may occur due to performance loss that results from the CPU power-saving function. Log on to Windows as an administrator and follow the steps below. <ol style="list-style-type: none"> 1. Click [Start] - [Run] and input "c:\util\cpupower\setup.exe", and click [OK]. Follow the on-screen instructions. 2. Click [Start] - [All Programs] - [Panasonic] - [CPU Idle Setting]. 3. Click [Performance] and click [OK], then click [Yes]. The computer is restarted automatically. <ul style="list-style-type: none"> ▪ If the problem persists, click [start] - [Control Panel] - [Performance and Maintenance] - [Power Options] - [Power Schemes], select [Always On] in [Power schemes], and click [OK]. <ul style="list-style-type: none"> ○ The above remedy is effective for performance loss resulting from the CPU power saving function, but not for other causes (e.g., noise generated by high CPU load such as video playback). ○ The above remedy slightly reduces the battery operation time. Normally it is recommended to select [Battery (Windows XP Standard)] in [CPU Idle Setting] and to select [Portable/Laptop] in [Power schemes].

*5 : Windows XP: standby

Touch Pad / Touchscreen (only for model with touchscreen)

<p>The cursor does not work.</p>	<ul style="list-style-type: none"> • Connect the external mouse correctly. • Restart the computer using the keyboard.
----------------------------------	---

	<p>Windows 7</p> <p>Press «  » and press «→» 2 times, and press «↑» to select [Restart] and press «Enter».</p> <p>Windows XP</p> <p>Press «  », «U», and «R» to select [Restart].</p> <ul style="list-style-type: none"> • If the computer does not respond to keyboard commands, read "No response".
Cannot input using the touch pad.	<ul style="list-style-type: none"> • Set [Touch Pad] to [Enabled] in the [Main] menu of the Setup Utility. • The touch pad may be disabled by some mouse drivers. Check your mouse's operating instructions.
<Only for model with touchscreen> Cannot point the correct position using the included stylus pen.	<ul style="list-style-type: none"> • Perform the "Touchscreen Calibration".
<Only for model with touchscreen> Cannot input using the touchscreen	<ul style="list-style-type: none"> • Set [Touchscreen Mode] to [Auto] or [Tablet] in the [Main] menu of the Setup Utility. If you still cannot use the touchscreen, perform the following procedures to install the touchscreen driver. <p>Windows 7</p> <p>Click  (start), input "c:\util\drivers\tscreen\TPSetup.exe" in [Search programs and files], and press «Enter».</p> <p>Windows XP</p> <p>Click [start] - [Run], input "c:\util\drivers\tscreen\ftsetup.exe" and click [OK].</p>
Cannot use scroll function of touch pad on Internet Explorer.	<ul style="list-style-type: none"> • Use Touchscreen. • Move the mouse cursor to outside of Internet Explorer, and return to Internet Explorer.

PC Card / ExpressCard (only for model with ExpressCard slot)

A card does not work.	<ul style="list-style-type: none"> • Insert the card correctly. • The card does not conform to the card standard. • Restart the computer after installing a driver (of card or other device). • Set [PC Card Slot] and [ExpressCard Slot] to [Enabled] in the
-----------------------	---

	<p>[Advanced] menu of the Setup Utility.</p> <ul style="list-style-type: none"> • The port settings are not correct. • Read the instruction manual of the card or contact the manufacturer of the card. • Remove the card and insert it again (➔ Inserting/Removing the Card). • The driver is not compatible with the operating system.
--	--

SD Memory Card

<p>Cannot use an SD Memory Card.</p>	<ul style="list-style-type: none"> • Set [SD Slot] to [Enabled] in the [Advanced] menu of the Setup Utility. • This computer may not support the maximum speed some types of SD/SDHC/SDXC Memory Cards guarantee.
--------------------------------------	---

Smart Card (only for model with Smart Card slot)

<p>Cannot use a Smart Card.</p>	<ul style="list-style-type: none"> • Insert the Smart Card correctly. • Set [Smart Card] to [Enabled] in the [Advanced] menu of the Setup Utility. • To use a Smart Card, you need a specified software and driver.
---------------------------------	--



Fingerprint Reader (only for model with Fingerprint Reader)

<p>The sensor does not enroll or authenticate my fingerprint.</p>	<ul style="list-style-type: none"> • Slide your finger correctly. For further information about enrollment and authentication, refer to How to Use the Fingerprint Reader and [Tutorial]. <ul style="list-style-type: none"> ○ Click  (Start)^{*6} - [All Programs] - [Protector Suite] - [Control Center] - [Help] - [Tutorial]. • The sensor enrolls or authenticates no fingerprint, or performs authentication poorly, despite the correct way of finger sliding when your finger is in any of the conditions stated below: <ul style="list-style-type: none"> ○ Rough skin, or injured finger (with a cut or a skin inflammation) ○ Extremely dry ○ Soiled with mud or oil ○ Fingerprint has been worn and has faded
---	---

	<ul style="list-style-type: none"> ○ Wet with water or sweat <p><You can improve enrolling and authentication sensitivity by taking the following steps when any of the conditions described above exists></p> <ul style="list-style-type: none"> ○ Wash your hands or wipe them dry. ○ Use a different finger for registration or authentication. ○ Treat your finger with a hand cream when it is rough skin or dry. <ul style="list-style-type: none"> ● Clean the fingerprint sensor. For further information, refer to Handling & Maintenance. ● The fingerprint sensor may be malfunctioning when it continues to perform poorly after the steps described above have been performed. Contact Panasonic Technical Support.
<p>Sensor does not work.</p>	<ul style="list-style-type: none"> ● Exported passport can help you if you need to replace the sensor. <ul style="list-style-type: none"> ○ Log on to Windows as an Administrator. You can always access the computer by using your Windows log on password. In convenient mode, any user can access the computer by using your Windows log on password. ○ To access [File Safe], [Personal Safe] [File Safe] can be always accessed by using the [File Safe] backup password. [Personal Safe] can be always accessed by using the [Personal Safe] backup password. ○ Other functions Replace/Repair the sensor, then follow the instructions in section Replacing sensor. Some limited functions (e.g. deleting passport) are available without a functional sensor. In case of deleted operation, it is necessary to cancel the fingerprint verification operation to get to the password dialog.
<p>User cannot use enrolled finger. (e.g. injury)</p>	<ul style="list-style-type: none"> ● It is strongly recommended to enroll at least two fingers to avoid this problem. If you enrolled multiple fingers, simply use other finger. If you only enrolled one finger that can be used, we recommend to use the [Manage Fingerprints] wizard and enroll additional fingerprints. <p>If none of your enrolled fingers can be used, follow this procedure:</p> <ol style="list-style-type: none"> 1. Log on to Windows as an Administrator.

	<p>You can always access the computer by using your Windows log on password. In convenient mode, any user can access the computer by using your Windows log on password.</p> <p>2. Update the enrolled fingerprints. To be able to fully use Protector Suite, you need to have usable enrolled fingerprints. Enter the [Manage Fingerprints] wizard.</p> <ul style="list-style-type: none"> ○ If you do not use backup password, you can still enter using the Windows password. ○ If you use backup password, you can enter using the backup password. ○ If you do not use backup password, there is no other way to add a different fingerprint. In this case we recommend either to wait until your finger is usable again (e.g. the injury heals), or to delete the passport (Use [Delete user data] wizard) and then reenroll new fingerprints. Please note that in the latter case all your stored secret data (passwords, [File Safe] encryption keys [Personal Safe] data) will be lost. To perform the delete operation it is necessary to cancel the fingerprint verification operation to get to the password dialog, then enter your Windows log on password. ○ To access [File Safe], [Personal Safe] If you did not perform the procedure in step 2 or it did not work, you can still access [File Safe] by using the [File Safe] backup password, [Personal Safe] by using the [Personal Safe] backup password.
<p>TPM failure.</p>	<ul style="list-style-type: none"> ● If you use fingerprint authentication with TPM (Trusted Platform Module) and TPM is broken, erased or disabled, the [Multifactor] will not work anymore. If you do not use the [Multifactor] backup password, refer to Starting Over. Otherwise, if you use backup password, you can follow these steps: <ol style="list-style-type: none"> 1. Click  (Start)^{*6} - [All Programs] - [Protector Suite] - [Control Center]. 2. Click [Identity] - [Multifactor]. 3. Set the method of authentication except for "fingerprint + TPM **".
<p>Replacing sensor.</p>	<ul style="list-style-type: none"> ● If you need to replace a non-functioning fingerprint reader, follow this procedure.

	<p>Enrollment to the hard disk: If enrollment to hard disk is used, "Protector Suite" has not stored any data on the device and therefore has no problem to continue after you replaced the sensor. However, in case you use the Power-on security (Preboot Authentication), you may need to use the [Manage Fingerprints] wizard to update the related data.</p> <p>Enrollment to the device: If the fingerprint has been enrolled to the device, a new passport will be required. Follow the procedure in the section Starting Over.</p>
<p>Protector Suite reinstallation.</p>	<ul style="list-style-type: none"> • Uninstall Protector Suite before reinstalling it. After uninstallation, reinstall Protector Suite (Installation). • During Protector Suite uninstallation, you can select whether to delete the Protector Suite Data - including passports. • To use password data or "Password Bank" data after reinstalling Protector Suite, select [Leave Protector Suite *.* data for later use]. After the new installation, you will be able to use your data again. • If you select [Remove all Protector Suite *.* data], you need to enroll fingerprint data again after reinstalling Protector Suite. In case of changing the Enrollment mode, reinstalling Protector Suite is necessary.
<p>Lost [File Safe] backup password.</p>	<ul style="list-style-type: none"> • It is necessary to change the backup password for [File Safe], refer to the Protector Suite Help menu. <ul style="list-style-type: none"> ○ Click  (Start)^{*6} - [All Programs] - [Protector Suite] - [Control Center] - [Help] - [Help].
<p>Accessing [File Safe] after Protector Suite uninstallation.</p>	<ul style="list-style-type: none"> • [File Safe] data can be accessed only using Protector Suite. If you accidentally uninstalled Protector Suite, you have to reinstall it. If passport data was not removed during uninstallation, everything will work automatically including [File Safe]. If the passport data was removed during uninstallation the [File Safe] will recognize that the installation was changed and will offer to use the backup password, instead.
<p>Accessing [File Safe] after computer crash.</p>	<ul style="list-style-type: none"> • If you have an exported passport, import it now so you can access [File Safe] directly using fingerprints. Otherwise you can access [File Safe] using the [File Safe] backup password: [File Safe] will recognize that the installation was changed and will offer to use the backup password, instead.
<p>Removing data from the</p>	

<p>reader.</p>	<ul style="list-style-type: none"> • When enrollment to the device is used, passport data is stored to the device. To remove it, go to the [Delete user data] passport wizard and delete existing passports.
<p>"Lift Finger" is displayed during operation.</p>	<ul style="list-style-type: none"> • You can temporarily disable the fingerprint sensor with the following procedure. <ol style="list-style-type: none"> 1. Click  on the notification area and then right-click the "Fingerprint software" icon . 2. Select [Don't Use Sensor]. • The icon turns gray. • To enable the fingerprint sensor, proceed as follows. <ol style="list-style-type: none"> 1. Right-click the "Fingerprint software" icon . 2. Select [Use Sensor].

*6 : Windows XP: [start]

Others

<p>No response.</p>	<ul style="list-style-type: none"> • Press «Ctrl» + «Shift» + «Esc» to open Task Manager and close the software application. • An input screen (e.g., password input screen at startup) may be hidden behind another window. Use «Alt» + «Tab» to check. • Shut down by pressing and holding the power switch for 4 seconds or longer, and turn on the computer and open the application again. If Windows runs correctly, but the application software does not start, perform the procedure below. <p>Windows 7</p> <p>Click  (Start) - [Control Panel] - [Uninstall a program] and remove the failing application software, then reinstall the application software.</p> <p>Windows XP</p> <p>Click [start] - [Control Panel] - [Add or Remove Programs] and remove the failing application software, then reinstall the application software.</p>
<p>A motion image file cannot be played using Windows® Media Player and the message [Codec required] appears.</p>	<ul style="list-style-type: none"> • Some motion image files require a Codec that is not installed as standard. In this case, connect to the Internet and try playback of the file again. The Codec may automatically be downloaded so you may be able to play it.

Checking the Computer's Usage Status

You can check the computer's usage status in the PC Information Viewer. You may need this information when calling Panasonic Technical Support for advice.

NOTE

- This computer periodically records the management information of the hard disk etc. The maximum data volume for each record is 1024 bytes. The information is only used for estimating the cause when the hard disk goes down by any possibility. They are never sent to outside via network nor used for any other purpose except for the purpose described the above.

To disable the function, add the check mark for [Disable the automatic save function for management information history] in [Hard Disk Status] of PC Information Viewer, and click [OK].

Windows 7

- A standard user needs to enter an administrator password.
- As long as it is activated, the PC Information Viewer will appear in front of all other screens.
- If you have not logged on with the administrator authority, some of Information will be displayed as [Not Found].

Windows 7

- Depending on your network environment, it may take sometime to start the PC Information Viewer.

-
1. Click  (Start)^{*7} - [All Programs] - [Panasonic] - [PC Information Viewer] - [PC Information Viewer].
 2. Select the item to display the detailed information.

To save the information as a text file

1. Display the information you want to save.
2. Click [Save].
3. Select the file save range option and click [OK].
4. Select the folder to save the information, input the file name, and click [Save].

- If you do not add the check mark for [Disable the automatic save function for management information history], the records already recorded are also saved.

To save a copy of the screen as an image file



1. Display the screen you want to save.
2. Press «Ctrl» + «Alt» + «F7».
3. When the screen copy message appears, click [OK].

The screen image is saved in [Documents]^{*8} folder.

- Alternatively you can save a copy of the screen in the following procedure.

Click  (Start)^{*7} - [All Programs] - [Panasonic] - [PC Information Viewer] - [Screen Copy].

NOTE

- The image is a bitmap file in 256 colors.
 - When using the extended desktop ( [Display Selector](#)), a copy of the primary device screen is saved.
 - The default key combination to copy is «Ctrl» + «Alt» + «F7». You can change it in the following procedure.
 1. Log on to Windows as an administrator.
 2. Click  (Start)^{*7} - [All Programs] - [Panasonic] - [PC Information Viewer].
 3. Right-click [Screen Copy] and click [Properties] - [Shortcut].
 4. Move the cursor to [Shortcut key] and press the key(s) you want to use for the shortcut.
 5. Click [OK].
-

*7 : Windows XP: [start]

*8 : Windows XP: [My Documents]